



 **SunTech**<sup>®</sup> *CT40*<sup>™</sup>  
VITAL SIGNS



# Spot-check Vital Signs Device

## User Manual

## Changes

This manual is identified as Part number: 80-0067-00. The most recent is available for download from the SunTech Medical website. Should you notice errors or omissions in this manual, please notify us at:

SunTech Medical, Inc.  
507 Airport Boulevard, Suite 117  
Morrisville, NC 27560 USA  
Tel: 800.421.8626  
919.654.2300  
Fax: 919.654.2301  
Email: [CustomerService@SunTechMed.com](mailto:CustomerService@SunTechMed.com)  
Web: [SunTechMed.com](http://SunTechMed.com)

## Copyright Information

All content in this manual is the proprietary of SunTech Medical and is provided solely for purposes of operation, maintenance or service of the SunTech CT40. This manual and the SunTech CT40 described herein are protected under copyright law under which states they may not be copied, in whole or in part, without written consent of SunTech Medical.

The information in this manual is furnished for guidance only, is subject to change without notice, and should not be construed as a commitment by SunTech Medical. SunTech Medical assumes no liability for errors or inaccuracies that may appear in this manual.

© 2019 SunTech Medical. All rights reserved.



SunTech Medical, Inc.  
507 Airport Blvd, #117  
Morrisville, NC 27560-8200  
Phone: 1-919-654-2300  
1-800-421-8626  
Fax: 1-919-654-2301



SunTech Medical, Ltd.  
Oakfield Industrial Estate  
Stanton Harcourt Road  
Eynsham, Oxfordshire OX29 4TS  
England  
Phone: + 44 (0) 1865-884-234  
Fax: + 44 (0) 1865-884-235

SunTech Medical (Shenzhen) Co., Ltd.  
105 HuanGuan South Road, Suite 15 2~3/F  
DaHe Community Guanlan,  
LongHua District, Shenzhen  
GuangDong PRC 518110  
Tel: + 86-755-29588810  
+ 86-755-29588986 (Sales)  
+ 86-755-29588665 (Service)  
Fax: + 86-755-29588829



## Welcome to the SunTech CT40

Thank you for choosing the SunTech CT40 for accurate spot-checking of vital signs.

The SunTech CT40 is designed to be simple and efficient to use and the CT40 features:

- mobility for improved and compact efficiency in a cost-effective package
- automatic BP checks
- averaging of multiple BP readings
- optional use of stethoscope for traditional auscultatory BP measurement
- robust memory
- connection to EMR system
- multiple options for pulse oximetry and temperature measurement

## SunTech CT40 Description and Operation

The CT40 vital signs device can perform automatic blood pressure, pulse oximetry and body temperature measurements for clinical professionals. For measuring blood pressure, a blood pressure cuff is placed around the patient's non-dominant upper arm. The cuff is inflated automatically, and blood pressure is determined by the oscillometric method—which senses pressure waves in the artery when occluded by pressure in the cuff. Measurement of the frequency of the pressure waves enables heart rate to also be measured. The pulse oximetry function non-invasively measures the patient's percent oxygen saturation of arterial hemoglobin using principles of plethysmography via a SpO<sub>2</sub> sensor placed on the patient's finger. Temperature can be measured using one of two different kinds of temperature probes. The oral/axillary/rectal temperature probe contains a thermistor that generates a voltage based on changes in temperature, and these voltages are recorded by the temperature circuitry. The touchless infrared temperature probe detects radiated infrared energy from the temporal artery. The CT40 is a portable device, approximately 205 x 190 x 140 mm in size and weighs approximately 1440 g without battery. Control buttons allow the user to stop/start a BP measurement, save a set of measurements to memory, change between BP modes, and return to the home screen. There is also a selection knob that is used to scroll and select different device options. The backlit LCD display shows the user device status and measurement information. The device uses a microprocessor with software, which is not accessible to the user. The unit is powered by a single rechargeable lithium-ion battery at the rear of the device. Two USB-A port connections can be used to connect, an optional printer, barcode scanner or Wi-Fi dongle. There is also RJ11 Ethernet port for network connectivity, and a mini-USB port used to connect the device to a PC or laptop for advanced device configuration.

*Note: For purposes of this manual, the SunTech CT40 (Model 260) may be referred to as “the SunTech CT40,” “the CT40” or “the device”.*

# Table of Contents

Changes.....	2	Touchless Thermometry Module*.....	32
Copyright Information.....	2	<b>9. Using SunTech CT40 EMR and Memory Functions</b>	<b>32</b>
Welcome to the SunTech CT40 .....	3	Barcode Scanner Setup.....	32
SunTech CT40 Description and Operation.....	3	Memory Mode.....	33
<b>1. Safety Considerations .....</b>	<b>5</b>	EMR Transmissions .....	34
Intended Use .....	5	<b>10. Taking Care of SunTech CT40.....</b>	<b>35</b>
Indications for Use.....	5	Cleaning .....	35
User Responsibility .....	5	Preventative Maintenance .....	35
Possible Adverse Reactions.....	6	Replacing and Disposal of the Battery .....	36
Warnings and Cautions .....	6	Battery Disposal.....	36
Icons, Symbols and Abbreviations.....	8	Product Disposal .....	36
Commonly Used Abbreviations .....	9	Cuff Disposal .....	36
<b>2. Setting Up the SunTech CT40.....</b>	<b>10</b>	Routine Calibration .....	36
Unpacking the Monitor .....	10	<b>11. Accessories &amp; Replacement Parts.....</b>	<b>37</b>
Rear Panel Configuration .....	10	Main Unit .....	37
Side/Temperature Panel Configuration .....	11	Masimo® SET SpO <sub>2</sub> Module.....	37
Side/SpO <sub>2</sub> Panel Configuration .....	11	ChipOx (Nellcor® Compatible) SpO <sub>2</sub> Module .....	38
Install Batteries .....	12	Covidien® FILAC® 3000 Temperature Module.....	38
Battery Disposal.....	12	Touchless IR Temperature Module .....	38
Attach Connections to the Device .....	13	Stands/Printer/Scanner .....	38
Mounting Options .....	13	Alternate Functional Scanners .....	38
System Configuration .....	13	<b>12. Status Messages &amp; Alarms .....</b>	<b>39</b>
<b>3. Getting to Know the SunTech CT40 .....</b>	<b>14</b>	Status Messages .....	39
Measurement Display .....	14	Out of Range Measurements .....	41
Control Panel.....	16	Service Centers.....	42
Monitor Setup.....	17	<b>13. Frequently Asked Questions .....</b>	<b>42</b>
To Set the Time and Date.....	17	<b>14. Technical Information .....</b>	<b>43</b>
Visual Alarms .....	17	EMC Statement.....	43
<b>4. Good to Know Before You Begin .....</b>	<b>18</b>	Specifications, General .....	49
Power Modes .....	18	Specifications, Blood Pressure Measurement .....	49
Documenting Measurements.....	18	Notes on Blood Pressure Data .....	49
Printing .....	18	SPO <sub>2</sub> Sensor Specifications .....	50
Saving Measurements.....	19	Temperature Sensor Specifications.....	50
<b>5. Using SunTech CT40 for BP Measurement .....</b>	<b>20</b>	Wi-Fi Dongle Specifications .....	50
Step 1: Preparing the Patient .....	20	Limited Warranty .....	51
Step 2: Select Between Adult Vs Pediatric Mode .....	20	Conflict Minerals .....	51
Step 3: Select Measurement Mode.....	20		
Step 4: How to Measure BP in Each Mode.....	23		
Step 5: Record Results.....	24		
Step 6: Prepare for New Patient.....	24		
<b>6. Using SunTech CT40 for Heart Rate Measurement</b>	<b>24</b>		
BP Heart Rate Measurement.....	24		
SpO <sub>2</sub> Heart Rate Measurement.....	24		
<b>7. Using SunTech CT40 for Pulse Oximetry .....</b>	<b>25</b>		
General Principle of Operation:.....	25		
System Description:.....	26		
Taking SpO <sub>2</sub> Measurements: .....	27		
Special Notes for Masimo® SET SpO <sub>2</sub> module: .....	27		
Special Notes for ChipOx SpO <sub>2</sub> module:.....	29		
<b>8. Using SunTech CT40 for Temperature Measurement.....</b>	<b>30</b>		
Covidien® FILAC® 3000 Thermometry Module .....	30		
Oral Temperature Taking.....	30		
Axillary Temperature Taking .....	31		
Rectal Temperature Taking .....	31		
Other FILAC® 3000 Temperature Settings .....	31		

# 1. Safety Considerations

## Intended Use

The SunTech CT40 is a clinical grade, automated blood pressure measurement device with optional temperature and pulse oximetry modules for spot-check vital sign measurements in physician offices, long-term care facilities, and low-acuity areas in hospitals. The CT40 can be used in combination with a clinical IT network to transfer and store patient measurement data on an EMR system.

## Indications for Use

The SunTech CT40 is a non-invasive oscillometric spot-check vital signs device. The CT40 is capable of measuring and displaying brachial systolic and diastolic blood pressure, heart rate, percent oxygenated hemoglobin (SpO<sub>2</sub>) and body temperature on children 3 years of age to adults. This device is intended for use by a qualified clinician when it is necessary to take a single or a series of vital signs measurements on a patient. The CT40 is only for measurement, recording and display. It makes no specific diagnoses.

The SunTech CT40 is intended to be used on adult and pediatric patients using appropriately-sized SunTech One-piece Durable (OPD) BP cuffs.

The device is intended to be used in outpatient departments, emergency treatment rooms, low-acuity areas of hospitals, community clinics, private clinics, and other medical institutions. It is not intended for helicopter transport, hospital ambulance or home use. It is not intended for near active HF SURGICAL EQUIPMENT and the RF shielded room of an ME SYSTEM for magnetic resonance imaging, where the intensity of EM DISTURBANCES is high.

## User Responsibility

Your SunTech CT40 is designed to perform in conformity with the description thereof contained in this operation manual and accompanying labels and inserts, when assembled, operated, maintained and repaired in accordance with the instructions provided.

Further, the user of this device bears sole responsibility for any malfunction that results from improper use, faulty maintenance, improper repair, damage or alteration by anyone other than SunTech Medical or authorized service personnel.

## Use of SunTech CT40

Use only One-piece Durable (OPD) BP cuffs supplied by SunTech Medical.

Observe the patient carefully during the measurement. Ensure pressure compatibility to all patients. If any abnormality occurs, either in the unit or the patient, suspend the operation immediately and disconnect the BP cuff, SpO<sub>2</sub> sensor and thermometer (if applicable) from the patient.

Accuracy of any BP reading, or oxygen saturation measurement may be affected by the position of the patient, their physical condition and use outside of the operating instructions detailed in this guide. The interpretation of BP and oxygen saturation measurements should only be made by a physician.

Safety and effectiveness when used with pregnant women, children under 3 years of age and neonates have not been established.

## Pulse Oximetry (SpO<sub>2</sub>)

ChipOx SpO<sub>2</sub> Module: Use only pulse oximeter (SpO<sub>2</sub>) sensors supplied by SunTech Medical or original Nellcor® pulse oximeter (SpO<sub>2</sub>) sensors supplied by Covidien® (except for forehead reflectance sensors).

Masimo® SpO<sub>2</sub> Module: Use only original Masimo® pulse oximeter (SpO<sub>2</sub>) sensors and cables.

Check the application site of the SpO<sub>2</sub> sensor frequently to confirm proper positioning of the sensor and to check the circulation and skin sensitivity of the patient.

## Wireless Networking

When connecting this device to a wireless network, it is important to use only the hardware specified by SunTech Medical (see Accessories section for details). Unsupported USB accessories, including unsupported Wireless adapters, have been intentionally disabled and will not function with this device.

## Possible Adverse Reactions

In the area of the BP cuff or SpO<sub>2</sub> sensor, allergic exanthema (symptomatic eruption) may result, including the formation of urticaria (allergic reaction including raised edematous patches of skin or mucous membrane and intense itching) caused by the fabric material of the cuff or sensor.

Following the application of the BP cuff, petechia formation (a minute reddish or purplish spot containing blood that appears in the skin) or Rumpel-Leede phenomenon (multiple petechia) may appear on the arm, which may lead to idiopathic-thrombocytopenia (spontaneous persistent decrease in the number of platelets, associated with hemorrhagic conditions) or phlebitis (inflammation of a vein).

## Warnings and Cautions



**WARNING:** Do not attach the cuff to a limb being used for IV infusions or any other intravascular access, therapy or an arteriovenous (A-V) shunt. The cuff inflation can temporarily block blood flow, potentially causing harm to the patient.

**WARNING:** Pressurization of the cuff can temporarily cause loss of functionality of SpO<sub>2</sub> if simultaneously using device on the same limb.

**WARNING:** Not designed for neonates.

**WARNING:** Do not apply the BP cuff to a limb being used for IV infusions as the cuff inflation can temporarily block the infusion, causing harm to the patient.

**WARNING:** Check frequently by observing the limb that operation of the AUTOMATED SPHYGMOMANOMETER does not result in prolonged impairment of the circulation of the patient.

**WARNING:** The cuff should not be applied over a wound as this can cause further injury.

**WARNING:** The cuff should not be placed on the arm on the side of a mastectomy. In the case of a double mastectomy use the side of the least dominant arm.

**WARNING:** The CT40 is NOT defibrillator protected.

**WARNING:** Do not use in the presence of flammable anesthetics or other flammable substances in combination with air, oxygen-enriched environments, or nitrous oxide.

**WARNING:** Do not use the device if it has failed its diagnostics self-test, or if it displays a greater than zero pressure with no BP cuff attached or a value of oxygen saturation with no SpO<sub>2</sub> sensor attached.

**WARNING:** Do not use if device is dropped and/or damaged. Have a qualified service representative check the unit before using again.

**WARNING:** Do not remove unit covers. Doing so may cause electrical shock to the user. The device does not contain any user serviceable components.

**WARNING:** Do not immerse the device in any fluid, place fluids on top, or attempt to clean the unit with any liquid detergents, cleaning agents, or solvents. This may cause an electrical hazard. Refer to the cleaning section of this guide for instructions on cleaning. If any of these situations apply, please contact SunTech Medical.

**WARNING:** Remove power before servicing device. Failure to remove power could cause electrical shock or death.

**WARNING:** A pulse oximeter should NOT be used as an apnea monitor.

**WARNING:** Pulse rate measurement is based on the optical detection of a peripheral flow pulse and therefore may not detect certain arrhythmias. The pulse oximeter should not be used as a replacement or substitute for ECG based arrhythmia analysis.

**WARNING:** Do not use the device or any of its accessories during magnetic resonance imaging (MRI) scanning. Induced current could potentially cause burns.

**WARNING:** Tissue damage can be caused by incorrect application or use of an SpO<sub>2</sub> sensor, for example by wrapping the sensor too tightly. Inspect the sensor site as directed in the sensor Directions for Use to ensure skin integrity and correct positioning and adhesion of the sensor.

**WARNING:** Do not use high frequency surgical equipment with the CT40 as this may cause loss of stored data

**WARNING:** No modification of this equipment is allowed.

**WARNING:** Federal (U.S.) law restricts this device to sale by or on the order of a physician.



**CAUTION:** A compressed, or kinked connection hose may cause continuous cuff pressure resulting in blood flow interference and potentially harmful injury to the patient.

**CAUTION:** Check calibration of this device annually.

**CAUTION:** Calibration should be done by biomedical technician or other authorized personnel.

**CAUTION:** Never knowingly use a defective device.

**CAUTION:** Immediately replace parts that are broken, worn, missing, incomplete, damaged or contaminated.

**CAUTION:** Contact the nearest SunTech approved service center should repair or replacement become necessary. A list of approved service centers appears in the guide or on our website at [www.SunTechMed.com](http://www.SunTechMed.com).

**CAUTION:** The reliability of the device depends upon conformance with the operation and service instructions, as detailed in this manual.

**CAUTION:** Only replace battery with same type and model number.

**CAUTION:** To avoid the risk of electrical shock, this equipment must be only connected to supply mains with protective earth.

**CAUTION:** Do not connect the device to equipment that does not meet EN60601-1. When the device is attached to a patient, the device's communication ports must only be connected to equipment that meets EN60601-1 standard.

**CAUTION:** Use only SunTech branded cuffs approved for use on the CT40 device.

**CAUTION:** Use only Masimo® oximetry sensors for SpO<sub>2</sub> measurements with the Masimo® SpO<sub>2</sub> module. Other oxygen transducers (sensors) may cause improper performance.

**CAUTION:** Do not use damaged SpO<sub>2</sub> or temperature sensors. Do not use a SpO<sub>2</sub> sensor with exposed optical components.

**CAUTION:** Do not immerse the SpO<sub>2</sub> or temperature sensors in water, solvents, or cleaning solutions (the sensors and connectors are not waterproof). Do not sterilize by irradiation, steam, or ethylene oxide. See the cleaning instructions in the Sensor Directions for Use.



















**CAUTION:** Do not use damaged patient cables. Do not immerse the patient cables in water, solvents, or cleaning solutions (the patient cable connectors are not waterproof). Do not sterilize by irradiation, steam, or ethylene oxide. See the cleaning instructions in the patient cable directions for use.

**CAUTION:** Do not position the device so that it is difficult to access and remove the power cord from the electrical supply. The AC power cord is the means of disconnection to the supply mains.













## Icons, Symbols and Abbreviations

### Icons and Symbols

The following icons and symbols are used in this guide, on the SunTech CT40 equipment and packaging.

	Warning message
	Caution message
	Manufacturer
	Manufacture Date
	Authorized representative in the European Community
	Catalog Number
	Serial Number
	Batch or Lot Code
	Fragile, handle with care
	Keep dry
	Temperature limit
	Humidity limitation
	Consult instructions for use
	Refer to instruction manual/booklet
	Type B
	Type BF Applied Part. Part is isolated from earth ground.
	Indicates that the device contains materials which may be hazardous to human health.
	CE Mark: Product meets the Medical Device Directive and is CE marked to indicate conformance
	SpO <sub>2</sub> Sensor. Type BF Applied Part



	USB-A or USB-B
	Warning: Federal (U.S.A.) law restricts this device to sale by or on the order of a licensed health care practitioner.
	Device includes RF transmitter.
	Indicates the arm circumference which is appropriate for the cuff
	Cuff index marker, OPD
	Artery marker indicating proper placement – Arrow and symbol should be placed over the brachial artery.
	Cuff range indication
	Device is not made with natural rubber latex
	Device is not made with PVC
	Class II Equipment
IPX1	Protection against vertically falling drops of water
	Expiration Date
	Single Use Only

## Commonly Used Abbreviations

BP	Blood Pressure
BPM	Beats Per Minute
EMR	Electronic Medical Record system
K-sounds	Korotkoff sounds
MAP	Mean Arterial Pressure (Not available in the U.S.)
DIA	Diastolic BP
NIBP	Non-Invasive Blood Pressure
OPD	One-piece Durable
SpO <sub>2</sub>	Percent Oxygen Saturation of Arterial Blood (hemoglobin)
SYS	Systolic BP

## 2. Setting Up the SunTech CT40

### Unpacking the Monitor

As you unpack your SunTech CT40, check to make sure you have all the proper components.

Refer to the separate packing label stating which components you received based on the options you ordered with your device.

### Rear Panel Configuration

SunTech CT40 connections on the back of the device:

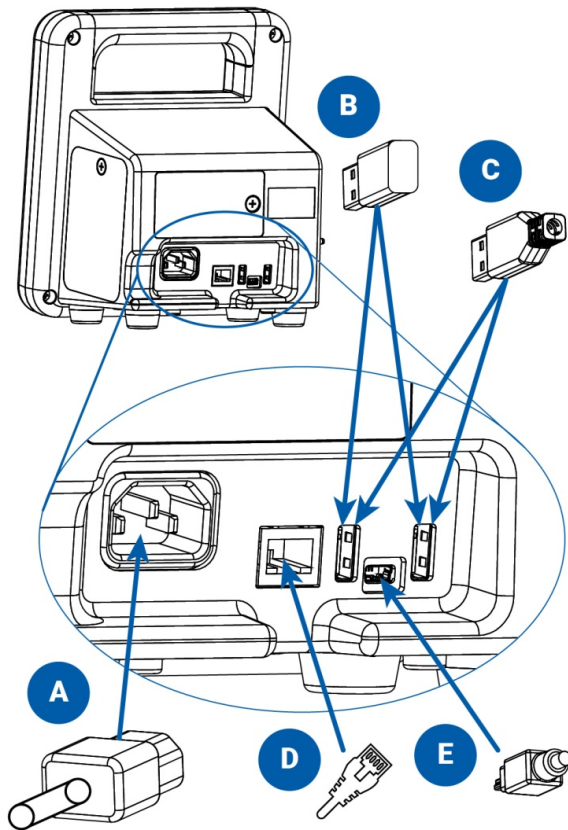

- A. Connect AC power cord
- B. Wi-Fi USB dongle (optional)
- C. Printer or barcode scanner USB cable (optional)
- D. Ethernet cable (optional)
- E. Mini USB cable to connect to PC or laptop

## Side/Temperature Panel Configuration

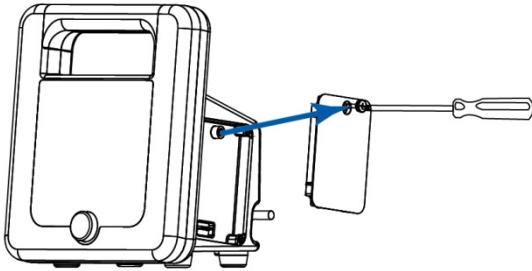

If no temperature module will be added, then attach the right panel of the CT40, using the included Phillips-head screwdriver. This panel will be on the right side, when the screen is facing the user.

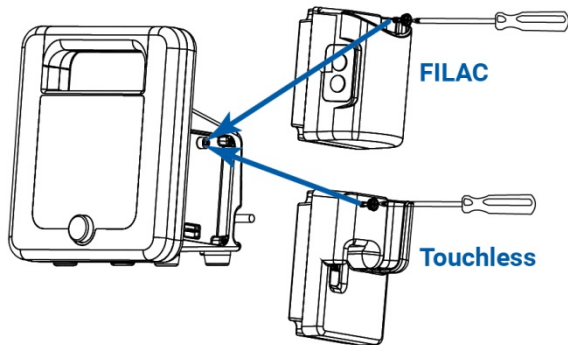

To add a temperature module, attach the module on the right side of the main unit. Fasten with the included Phillips-head screwdriver.

For FILAC®:

Temperature unit connector: Insert the probe/well-assembly into the top of the FILAC® module.

For Touchless:

Plug in the touchless thermometer cable connector into the already inserted module.

## Side/SpO<sub>2</sub> Panel Configuration

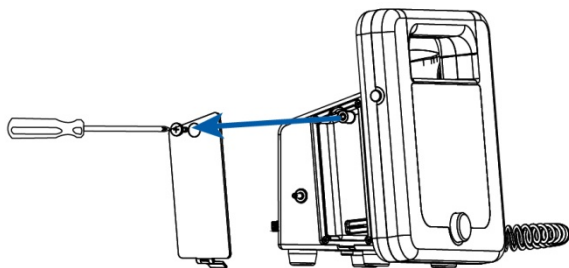

Remove the left panel of the CT40, using a Phillips head screw driver. This panel will be on the left side, when the screen is facing the user.

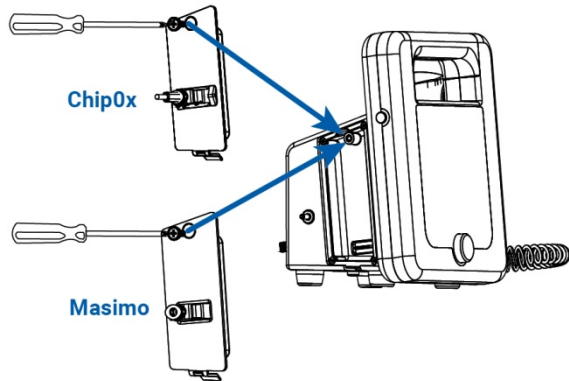

To add an SpO<sub>2</sub> module, attach the module on the left side of the main unit. Fasten with the included Phillips-head screwdriver.

For Masimo®:

Attach the Masimo® extension cable to the connector on the module, making sure that the connectors lock together. Then, attach the Masimo® SpO<sub>2</sub> sensor to the other end of the extension cable making sure that the retaining clip is in place.

For ChipOx:

Attach the ChipOx SpO<sub>2</sub> sensor to the connector on the module while the retention clip is held upwards. Once the sensor/cable connector is inserted, push the clip downward over the connector to hold it securely in the module. For easy insertion, ensure module is parallel to the device.

## Install Batteries

Install the rechargeable battery into the battery bay. Please read the battery instructions and the label on its surface before use. Allow 8 to 12 hours for charging. All segments of the Battery Symbol will be lit when the device is fully charged.



**CAUTION:** Fire, explosion and severe burn hazard. Replace only with SunTech part number: 17-0022-00.

If not installed in the device, the battery shall be kept away from heat, fire or other high temperature environments. Keep the battery in a dry place stored at room temperature.

Do not disassemble, attempt to repair or use the battery for any other device or for any other purpose.

Do not place near any metal or use metal to shield the battery from physical damage as this may cause battery overheating and/or a fire risk.

Do not short across the contacts of the battery or attempt to discharge the battery by shorting as a risk of fire or explosion may result.

Do not expose or immerse the battery in water or attempt to clean with any cleaning agents. Only wipe battery with a damp cloth if necessary.

Wash the affected area if electrolyte spills on skin or clothes. Leaking electrolyte may cause discomfort to the skin. If it gets into the eyes, do not rob the eyes. Flush eyes immediately with water and seek medical attention.

## Battery Disposal



The SunTech CT40 device contains a lithium ion battery that contains materials which may be hazardous to human health. Do NOT dispose of battery in domestic waste! Instead, please dispose of in an environmentally responsible way, or return the battery to SunTech Medical. A prepaid return label can be obtained. Please see our

website for more information about our environmental policy at <http://www.suntechmed.com/about-suntech/environmental-policy>.

## **Attach Connections to the Device**

After connecting the Power Cable, plug into an available AC power outlet to charge batteries.

Connect the BP cable, SpO<sub>2</sub> sensor cable, and temperature sensor (if option is included) to the device.

Connect the barcode scanner and/or printer to the device if these options are included.

Use the Power Button on the left side of the SunTech CT40 to turn it on.

*NOTE: The blue LED around the Selection Knob will be lit whenever the device is powered on.*

## **Mounting Options**

The SunTech CT40 is designed to be used on a tabletop or mounted to a wall or mobile stand. Your device may be delivered with the appropriate mounting kit, depending on the configuration your facility ordered. Please see the separate mounting hardware instructions.

## **System Configuration**

The SunTech CT40 can be used out of the box with the factory settings. Any changes desired to the factory settings can be made using the Advanced Configuration Application. The Advanced Configuration Application can be accessed when the device is connected to a Windows device. Advanced configuration, such as connecting to a network or EMR system, should be done by a qualified technician. See Advanced Configuration Application Guide (SunTech document 80-0072-00-MO) for details.

Advanced device configuration, such as choosing either BP or SpO<sub>2</sub> as the pulse rate source or activating MAP measurement (not available in the U.S.), is also done using the Advanced Configuration Application.

### 3. Getting to Know the SunTech CT40

#### Measurement Display

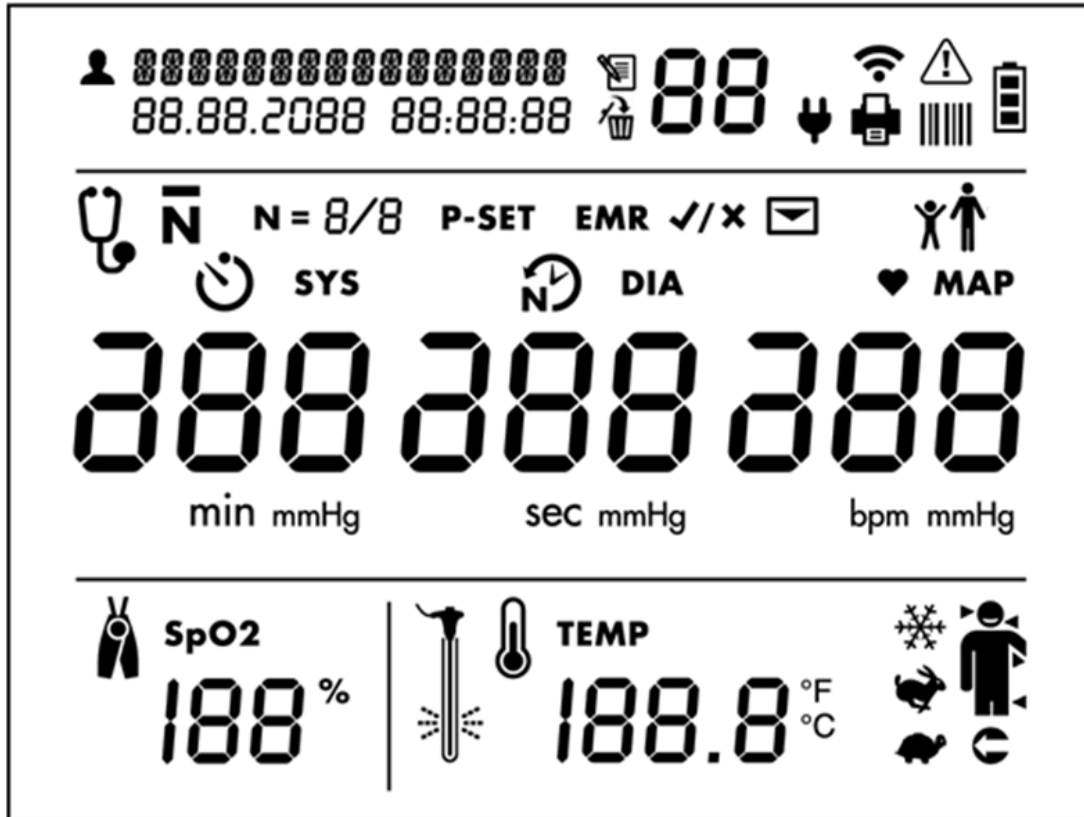

#### Patient Identification and Date/Time Stamp

 Patient ID

#### Memory Mode Information

 Memory icon

 Memory Delete icon

#### Connections to Ancillary Devices and Networks

 : Wi-Fi radio on (segments will illuminate in series)

 Wi-Fi radio connected (segments will be illuminated continuously)

 AC power connected

 Printer connected and powered on

 Barcode scanner connected and powered on

### Error Alert Symbol

**WARNING:** User must take immediate action (see additional information in Section 12)

### Battery Level Indicator

 Battery symbol (All bars illuminated indicate a full charge)

### Blood Pressure Measurement Mode Selection Icons

: Auscultatory Sphygmomanometer Mode

: Averaging mode

**N** =: Number of measurements taken in averaging mode

**P-SET** : Maximum pressure setting for Auscultatory Sphyg Mode

: Time before first measurement in minutes (Illuminates when Averaging Mode is selected)



: Time between measurements in seconds (Illuminates when Averaging Mode is selected)

### Blood Pressure Results (DIA and SYS)

**DIA** and **mmHg**: Diastolic blood pressure

**SYS** and **mmHg**: Systolic blood pressure

### EMR Transmission Icons

**EMR**  : EMR icon prompts the user to confirm whether to send measurement data as message to EMR system. (Only shown if EMR connectivity has been set up via Configuration Application.)

: Message icon (Indicates if EMR messaging is successful)

If successful, the icon will flash on and off with check mark.

If not successful, it will flash on and off with X.

### Adult or Child Patient Selection

Press and hold toggle button for 4 seconds, until selection knob starts flashing. Release toggle button and use the selection knob to select the icon needed. Selected icon will blink after 1 second. Press the selection knob to confirm the selection.

: Adult BP Mode icon. This icon is illuminated when the Adult BP mode is selected.

: Pediatric BP Mode icon. This icon is illuminated when the Pediatric BP mode is selected. The CT40 will remain in the selected patient mode until a new mode is selected.

### Heart Rate and MAP Measurements

: Measured in BPM (Beats per minute), is illuminated when a heart rate is shown in the heart rate display.

**MAP:** Measured in mmHg is illuminated when a MAP value is shown (only if MAP functionality is enabled). **NOTE:** This is a factory setting. MAP is not available in the U.S.

### Pulse Oximetry Measurement Display

 **SpO2** : Expressed in % of arterial oxyhemoglobin

### Temperature Measurement Settings and Results Display

 **TEMP** : Body temperature in either Fahrenheit or Celsius (user selectable)

 : Cold Pre-heat mode

 : Predictive mode

 : Direct mode

 : Human thermometry mode. Temporal (arrow on left side of head), Oral (arrow on right side of head), Axillary (arrow under arm), or Rectal (arrow pointing to rectum).

 : Object thermometry mode. Illuminates when object thermometry mode has been selected.

 : Apply temp probe cover

### Control Panel

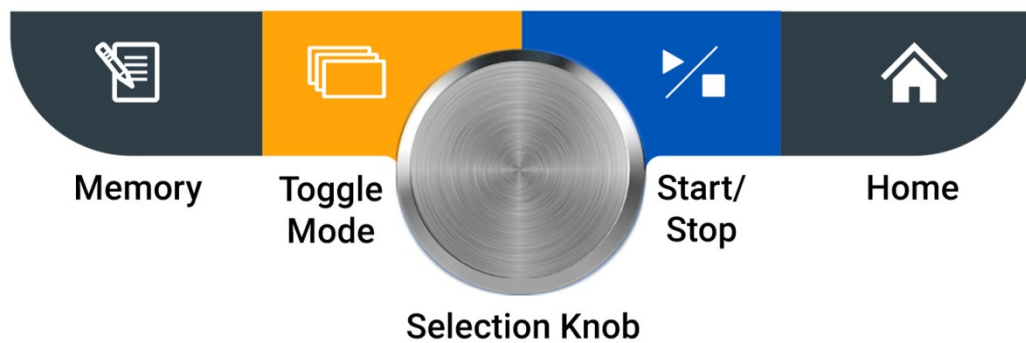

#### Memory Button

Press this button to enter Memory Mode and to store, view or delete saved measurements.

**Save Current Reading:** A quick press gives the user an option to save the patients reading, suggested to be done after each reading.

**Access Previous Reading:** A long press (holding the button down for 4 seconds) gives the user the option to access the bank of prior readings. Please see Section 4 to read more about the saving and accessing saved readings.



## Toggle Mode Button

Press this button to toggle between three different BP measurement modes: Single Measurement, Averaging Measurement and Auscultatory SphygMode.

A quick press gives the user an option to switch between BP measurements modes.

A long press (holding the button down for four seconds) gives the user the option to switch between pediatric or adult mode. More information on switching from adult to pediatric mode can be found in Section 5.

## Selection Knob

This round knob rotates clockwise and counterclockwise and can be pressed in to select different options on the SunTech CT40. This button can be used to change parameters and to set the intended parameter.

## Start/Stop Button

Press this button to start or stop a BP measurement.

## Home Button

Pressing this button returns you to the single measurement mode.

## Monitor Setup

Press the power button to start Initial Power-up. The display will gradually illuminate over a 3-second period. If this is the first time the device has been turned on since it left the factory or since the device was set to factory defaults, the user will be prompted to set the time and date in the following format: MM.DD.YYYY HH:MM:SS. The “MM” portion of the field will flash first, prompting you to set the month. Turn the Select Knob to select the appropriate month and press the Selection Knob. Then the next field, “DD” will flash, prompting you to select the day, and so on and so forth, until you have set “SS” for seconds.

After setting the date and time, the device is ready to use! It is possible to make additional configuration changes to the SunTech CT40 using the Advanced Configuration Application.

## To Set the Time and Date

The time and date can be changed by simultaneously holding both the Power and Start/ Stop buttons for 6 seconds. Refer to the previous section “Monitor Setup” for instructions on setting the time and date using the selector knob.

The SunTech CT40 Vital Signs Monitor also allows for Automatic Time Synchronization via Network (NTP) settings. Refer to the advanced configurations manual for information regarding either of these changes.

## Visual Alarms

When an error occurs, the Warning icon will blink, in addition to the relevant parameter experiencing the error.

Blood pressure error is displaced in the BP heart rate field.

Temperature error will displace in the lower right hand.

SpO<sub>2</sub> error will displace in lower left side of the screen.

Battery symbol will flash if error is related to battery.

Depending on the out-of-range value, the display will indicate whether the value is out-of-range (hi) or out-of-range (lo). If the out-of-range parameter is the systolic or diastolic pressure (or both), and MAP is enabled, MAP is not displayed for that measurement. **NOTE: MAP is not available in the U.S.**

See Section 12, “Status Messages and Alarms,” for more details.

## 4. Good to Know Before You Begin

### Power Modes

**Initial Power-up** occurs the first time the device is turned on after being received from the factory, after the device has been reset to factory defaults or after the battery has been changed. See “Monitor Setup” for information about Initial Power-up.

**Nominal Power-up** refers to every time the device is turned on after Initial Power-up. Simply press the power button and the display will illuminate.

*NOTE: The blue LED around the Selection Knob will be lit whenever the device is powered on.*

**Power-down** occurs when you press the power button when the device is powered up. During power-down, all LCD segments and icons illuminate for 1 second and then the entire display gradually darkens from normal brightness to black and then one beep sounds. At this point, the device enters **Sleep Mode**, a low-power state, and is considered off.

**Automatic Power-down** occurs when the device has not been used (i.e., no measurements taken, or buttons pressed) for 1 hour. The device will automatically execute the Power-down sequence and enter Sleep Mode.

Your SunTech CT40 offers flexibility to function in ways that best meet your work setting.

### Documenting Measurements

Before you start taking measurements, it's important to document the patient ID per your facility's procedures. To do so, the barcode scanner must be used to enter the patient ID into the CT40.

#### With a Barcode Scanner

If your SunTech CT40 is connected to a barcode scanner, you can scan your patient's barcode ID and it will show at the top left of your screen. Then, the patient ID will remain attached to all measurements taken, saved in memory, and/or sent to your facility's EMR.

#### Without a Barcode Scanner

If you don't require a barcode scanner, all measurement results will be displayed on the main screen and can be saved to the device's memory, written down in a chart, printed out (with optional thermal printer) or captured in another way that meets your facility's documentation procedures.

### Printing

The SunTech CT40 can be connected to an optional SunTech thermal printer to easily print out measurement results. See Section 11 for ordering information.

After connecting the optional CT40 thermal printer (see Section 2 and Section 3), ensure that the green LED on the top of the printer is lit and unblinking before printing.



Reset

Print



To print the information currently displayed on the CT40 screen, press the print button on the top of the printer (see diagram above).

## Saving Measurements

### With EMR Connectivity

Technicians may have already connected the SunTech CT40 to your facility's EMR system. If so, you can easily send measurements directly to the EMR.

With the patient's current measurements displayed on the screen, press the Memory button . The EMR icon and Check Mark icon **EMR ✓** will begin flashing.

Press the Selection Knob to send the data to the EMR. If the measurements are delivered to the EMR successfully, you will see the EMR Message icon  and the Check Mark icon  blink four times.

To store the displayed measurements in the device memory without sending to the EMR:



Press the Memory Button .

While the EMR and Check Icons are flashing, turn the Selection Knob until the X icon  is displayed and then press the Selection Knob. The measurements will be saved to the device memory only.

### Without EMR

The SunTech CT40 does not have to be connected to an EMR system to save measurements. You can save them to the device's own memory. With the patient's current measurements displayed on the screen:

Press the Memory button .

All the measurement values on the screen, the Check icon  and the Memory icon  will flash on and off 2 times.

The display will then return to a blank screen/shows null values, but the Check Mark icon  will flash 2 more times, this verifies the measurements are successfully stored to the device's memory.

*Note: The CT40 does not autosave. The user must save the reading to memory after every reading.*

To view results stored in memory, press the Memory Button  for more than four seconds. You will see the most recently saved measurements displayed on the screen and can turn the Selection Knob counterclockwise to see older measurements and then clockwise to see newer measurements.

TIP: When you send results to memory, make note of the "Memory Location" number to keep track of an individual patient's measurements. Then later, you can match the Memory Locator number with a patient's name if you pull up or print out results for documentation.

The memory will hold up to 99 records. At 100 readings the device will continue to save but will save by overwriting the oldest records.

## 5. Using SunTech CT40 for BP Measurement

The SunTech CT40 provides flexibility to allow you to measure BP using several different modes, depending on your facility's preferred procedure, the patient's condition or other care considerations.

### Step 1: Preparing the Patient

#### Patient Position

According to AHA guidelines, the patient should be seated for at least five minutes before taking a blood pressure reading. The patient should be seated with feet flat on the floor and back supported. The patient's upper arm should be fully supported and resting at heart level. Encourage the patient to relax, and to be still and quiet.

#### Select and position BP cuff

Selecting the wrong size cuff will produce an inaccurate blood pressure measurement. When wrapped around the patient's arm, the Cuff Index Line should fall within the Range Markers printed on the cuff. If not, select a larger or smaller cuff to ensure optimal BP measurement accuracy. The Artery Marker printed on the cuff must point to the brachial artery, located inside the patient's upper arm, between bicep and tricep. Wrap the cuff snugly around the patient's upper arm, so that the bottom edge of the cuff is approximately 1 inch above elbow joint.

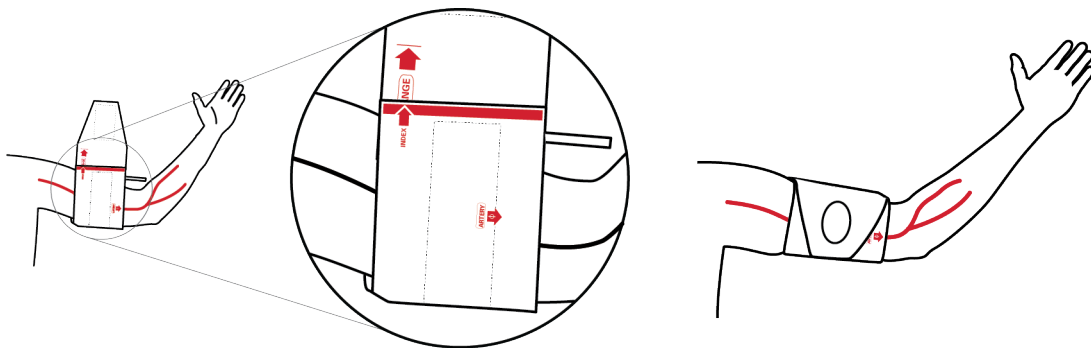

### Step 2: Select Between Adult Vs Pediatric Mode

The SunTech CT40 offers two different measurement modes for two very different types of patients: Adults and Pediatric patients (children between the ages of 3 and 12).

To switch between Adult and Pediatric modes:

 : Adult BP Mode icon     : Pediatric BP Mode icon

Hold the Toggle Mode button  down for 4 seconds until the adult and pediatric icons start blinking.

Turn the Selection Knob in either direction to select the desired icon

After making your selection, wait 2 seconds. The selected icon will be the one flashing.

Once you have selected the intended mode, press the Selection Knob to finalize this selection.

*Note: Adult and Pediatric mode can be used in conjunction with any type of measurement mode.*

### Step 3: Select Measurement Mode

The SunTech CT40 offers three different ways to measure BP.

Automatic Single BP: You can take a single, automatic measurement (Single Measurement Mode).

Averaged BP: Automatically take and average up to 5 multiple BP measurements (Averaging Measurement Mode).

Auscultatory/ Sphyg mode. Allows you to verify an automated oscillometric BP reading with a manual auscultatory measurement (Auscultatory SphygMode).

*Note: Use of Auscultatory SphygMode may be required to meet certain clinical trial protocols. It also can be used to verify a BP reading if the automated BP results diverge significantly from a patient's prior history, or if you as the clinician deem it necessary. Auscultatory SphygMode mimics a traditional sphygmomanometer and does not measure Systolic or Diastolic blood pressure.*

*Note: Averaging Measurement Mode can only be used for Automatic BP Measurements. It cannot be used to automatically average measurements taken in Auscultatory SphygMode.*



### Single Measurement Mode

This is the device's default mode. The SunTech CT40 will be in this mode each time it is powered up

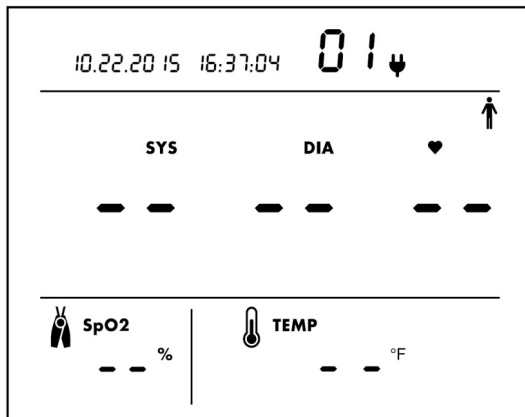
Pressing the Home button will revert to single measurement mode.



Example of center display when Single Measurement Mode is selected

*Note: If you see the Auscultatory SphygMode Icon  or the Averaging Mode Icon , press the Mode Toggle Button*



*in succession until these icons no longer show to return to Single Measurement Mode.*

### Averaging Measurement Mode

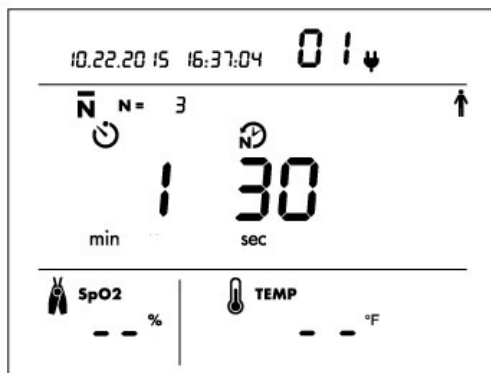

Select Mode

Set # of Measurements to Average

Set Time Between Measurements

Press the Mode Toggle Button



until you see the Averaging Measurement Mode Icon  $\bar{N}$ .  $\bar{N}$ . From single measurement mode, that will only be one button press.

The Number of Measurements Icon  $N =$  will flash as will the Selection Knob. To keep the default of 3 measurements, press Knob. Or turn Knob to choose a different number and press Knob to select.

Default values for Time Before First Measurement  $\text{⌚}$  and Time Between Measurements  $\text{⌚}$  will flash in sequence as the user is prompted to set each value. To keep defaults, press Knob. Or turn Knob to choose new values and press Knob to select.

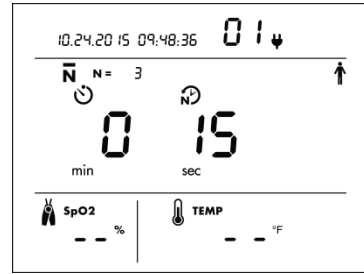
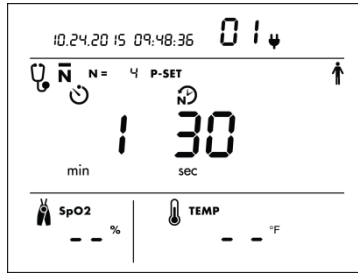
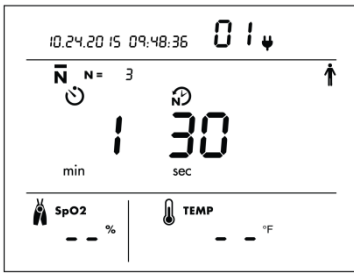

Example of Averaging Measurement Mode setup screen with default values.

You can select 2 to 5 measurements to average\*. In this example, 4 measurements are set to be averaged.

On left is Time Before First Reading will start. Select 0-5 min. Default = 0. On right is Time Between Measurements. Select 15-120 sec. Default = 15 sec.

\*Note: In averaging mode, you are unable to see individual readings. Averaged Results will be displayed at the end of all the readings. By default, all measurements taken (from 2 to 5) will be included in the averaging calculation. Using the Advanced Configuration Application, the device can be programmed to always throw out the first measurement taken and not include it in the averaging calculation.

\*\*Note: All values selected during the Averaging Measurement Mode will be displayed the next time that this mode is used, so that the same customized averaging protocol can be set and used each time that Averaging Measurement Mode is used.

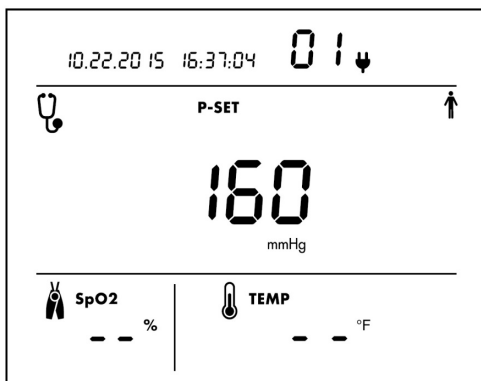

### Auscultatory SphygMode



Example shows Auscultatory SphygMode setup display. Three-digit number is the target cuff inflation pressure setting. The default is 160 mmHg.

Select Mode

Choose a Pressure Value

Press the Mode Toggle Button  until you see the Auscultatory SphygMode Icon .

From single measurement mode, that will be two button presses.

The pressure setting icon **P-SET** and Selection Knob will flash. To keep the default maximum cuff inflation setting of 160 mmHG, press the Knob. Or choose another pressure level between 100-280 mmHG and press the Knob to select. The device will remember the pressure setting and display the same pressure setting the next time SphygMode is used.

## Step 4: How to Measure BP in Each Mode

When in the appropriate home screen (see above)

### Single Measurement Mode

Ensure values are cleared from display except for SYS value representing current pressure in cuff.

Press Start/Stop Button



Inflate/deflate cycle proceeds automatically until results are displayed.

A long beep will sound to indicate measurement is complete.

### Averaging Measurement Mode

When selecting this mode, the **N =** will flash to allow the user to decide how many readings they would like averaged.

Select number of readings by rotating the selection knob and push the selection knob to set the number of readings.

The minute number will flash, and the user can select how many minutes until the first reading starts by rotating and pushing the selection knob.

The user can then select how often the readings will occur and select this by rotating the knob and pushing the knob to selection wanted.

The timer will then count down the seconds until the first reading.

After all measurements are taken and averaged, results will display.

A long beep will sound to indicate measurement is complete.

### Auscultatory SphygMode

Put stethoscope over artery.

Press Start/Stop  to inflate cuff automatically. Similar to an analog sphyg gauge, the display shows current pressure in cuff. When cuff reaches max pressure, deflation will begin automatically.

Listen for K-sounds while watching displayed pressure. Note SYS and DIA.

Press Start/Stop  again to quickly dump remaining pressure from the cuff.

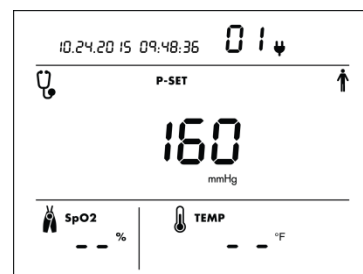
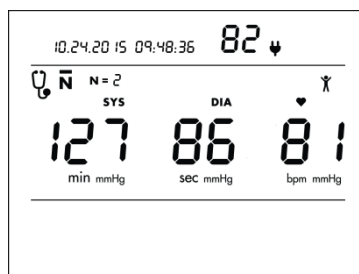
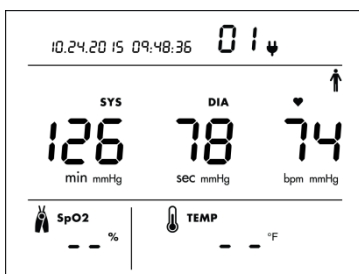

*Example of SYS, DIA and HR\* after BP measurement in Single Measurement Mode.*

*Example of SYS, DIA and HR\* after all measurements have been averaged.*

*Example of SphygMode display with cuff pressure at zero. P-set value is default 160 mmHg.*

*\*Note: Pulse rate source, whether BP or SpO<sub>2</sub>, can be selected at any time using the Advanced Configuration Application. The default setting uses BP as HR source. If used outside of the United States, the device also can be configured to measure MAP using the Configuration Application. If set up to measure MAP, the MAP and HR measurements will alternate in 3-second intervals. **NOTE: MAP is not available in the U.S.***

## Step 5: Record Results

When the measurement cycle is complete, values will be displayed for systolic and diastolic pressure, plus heart rate if BP is selected as the pulse rate source. \* Manually record, print and/or digitally save your measurements according to your healthcare facility's preferred process. To send results to an EMR or to the device memory, follow the steps in Section 4.

## Step 6: Prepare for New Patient

After all measurements have been recorded or captured, remove the cuff from the patient and clean it according to your facility's requirements. This disinfecting and storage step applies to BP cuffs as well as other optional accessories whose use will be covered in the following sections.

Pressing the Memory Button  will clear all patient and measurement data from the display, in addition to saving the patient and measurement information in memory. It is recommended that the display is cleared before taking readings on a new patient.

# 6. Using SunTech CT40 for Heart Rate Measurement

There are two ways to measure heart rate with the SunTech CT40.

## BP Heart Rate Measurement

With this method, HR is captured automatically during BP measurement.

## SpO<sub>2</sub> Heart Rate Measurement

If you have the optional pulse oximetry module on your device, you can measure HR through the SpO<sub>2</sub> sensor. See next section (section 7) for more on use of this option.

The SunTech CT40 uses BP as the default HR source. HR source can be selected using the Advanced Configuration Application.



## 7. Using SunTech CT40 for Pulse Oximetry

An optional SpO<sub>2</sub> module allows you to measure the oxygen saturation of arterial blood flow and display the reading on the SunTech CT40. There are two different types of optional SpO<sub>2</sub> modules: Masimo® SET® and ChipOx.

### General Principle of Operation:

The pulse oximeter directs red and infrared light into a capillary bed and measures the change in light absorption during the pulsatile cycle. Red and infrared light-emitting diodes (LEDs) in oximetry sensors serve as the light sources, and a photodiode serves as the photo detector.

Traditional pulse oximetry assumes that all pulsations in the light absorbance signal are caused by oscillations in the arterial blood volume.

The traditional pulse oximeter calculates the ratio of pulsatile absorbance (AC) to the mean absorbance (DC) at each of two wavelengths (typically one visible, the other infrared). The oximeter then calculates the ratio of these two arterial absorbance signals. This value is used to find the saturation SpO<sub>2</sub> in a standard table built into the oximeter software. The values in the table are based upon human blood studies against a laboratory co-oximeter on healthy adult volunteers in induced hypoxia studies. The resulting value is reported as oxygen saturation level (%).



**WARNING:** Pulse oximeter probes and sensors are designed for use with specific pulse oximeter devices. Only use probes and extension/adapter cables that are specified for each SpO<sub>2</sub> module.

**WARNING:** The responsible organization and/or operator must verify the compatibility of the oximeter, oximeter probe, and extension/adapter cable before use. Otherwise, patient injury can result.

**WARNING:** Misapplication of a pulse oximeter probe with excessive pressure for prolonged periods can induce pressure injury.



**CAUTION:** Inaccurate measurements may be caused by:

Incorrect sensor application or use. Proper sensor uses, and placement is critical for good performance.

Significant levels of dysfunctional hemoglobin. (e.g., carboxyhemoglobin or methemoglobin)

Intravascular dyes such as indocyanine green or methylene blue.

Dyes or any substance containing dyes that affect light absorption may cause erroneous readings.

- Some nail polish colors (particularly dark shades) or artificial fingernails may reduce light transmission and affect pulse oximetry accuracy. Remove any nail polish or artificial fingernails before using the SpO<sub>2</sub> sensor.

Exposure to excessive illumination, such as surgical lamps (especially ones with a xenon light source), bilirubin lamps, fluorescent lights, infrared heating lamps, or direct sunlight (exposure to excessive illumination can be corrected by covering the sensor with a dark or opaque material)

Excessive patient movement.

- Abnormal pulse rhythm.

Placement of a sensor on an extremity with a blood pressure cuff, arterial catheter, or intravascular line. Always place the SpO<sub>2</sub> sensor on the arm without a blood pressure cuff, arterial catheter, or intravascular line.

**CAUTION:** Pulse rate measurement is based on the optical detection of a peripheral flow pulse and therefore may not detect certain arrhythmias. The pulse oximeter should not be used as a replacement or substitute for ECG based arrhythmia analysis.

**CAUTION:** SpO<sub>2</sub> is empirically calibrated to functional arterial oxygen saturation in healthy adult volunteers with normal levels of carboxyhemoglobin (COHb) and methemoglobin (MetHb). A pulse oximeter cannot measure elevated levels of COHb or MetHb. Increases in either COHb or MetHb will affect the accuracy of the SpO<sub>2</sub> measurement.

**CAUTION:** COHb levels above normal tend to increase the level of SpO<sub>2</sub>. The level of increase is approximately equal to the amount of COHb that is present.

**CAUTION:** High levels of COHb may occur with a seemingly normal SpO<sub>2</sub>. When elevated levels of COHb are suspected, laboratory analysis (CO-Oximetry) of a blood sample should be performed.

**CAUTION:** For increased MetHb, the SpO<sub>2</sub> may be decreased by levels of MetHb of up to approximately 10% to 15%. At higher levels of MetHb, the SpO<sub>2</sub> may tend to read in the low to mid 80s. When elevated levels of MetHb are suspected, laboratory analysis (CO-Oximetry) of a blood sample should be performed.

**CAUTION:** Venous congestion may cause under reading of actual arterial oxygen saturation. Therefore, assure proper venous outflow from monitored site. Sensor should not be below heart level (e.g. sensor on hand of a patient in a bed with arm dangling to the floor).

**CAUTION:** Venous pulsations may cause erroneous low readings (e.g. tricuspid valve regurgitation).

**CAUTION:** The pulsations from intra-aortic balloon support can be additive to the pulse rate on the oximeter pulse rate display. Be sure to verify patient's pulse rate.

**CAUTION:** Elevated levels of Total Bilirubin may lead to inaccurate SpO<sub>2</sub> measurements.

**CAUTION:** With very low perfusion at the monitored site, the readings may read lower than core arterial oxygen saturation.

**CAUTION:** Do not immerse the sensor or patient cable in water or, solvents, or cleaning solutions (The sensors and connectors are not waterproof).

**CAUTION:** Loss of pulse signal can occur in any of the following situations:

The sensor is too tight.

There is excessive illumination from light sources such as a surgical lamp, a bilirubin lamp, or sunlight.

A blood pressure cuff is inflated on the same extremity as the one with a SpO<sub>2</sub> sensor attached.

The patient has hypotension, severe vasoconstriction, severe anemia, or hypothermia.

There is arterial occlusion proximal to the sensor.

The patient is in cardiac arrest or is in shock.

*NOTE: See SP02 Sensor Specifications Table on page 45, the range of the peak wavelengths and maximum optical output power of the light emitted by the pulse oximeter probe, which can be especially useful to clinicians.*

*NOTE: This device does not include an alarm system that detects an SpO<sub>2</sub> or pulse rate physiological alarm condition. This device is not designed for long-term monitoring and should only be used for spot-check measurements.*

## **System Description:**

The SunTech CT40 spot check device with pulse oximetry module consists of a base CT40 device for the display of SpO<sub>2</sub> measurement data and other user information, either a ChipOx or Masimo SET SpO<sub>2</sub> module which is attached to the CT40 base unit as described in **Section 2**, and the specific reusable pulse oximeter probe and/or cable that

comes packaged with each module. Device setup is described in more detail in **Section 2**. Both the Masimo® SET and ChipOx SpO<sub>2</sub> modules are calibrated to display functional oxygen saturation (SpO<sub>2</sub>).

### Taking SpO<sub>2</sub> Measurements:

1. Insert a finger (preferably the index, middle or ring finger) into the SpO<sub>2</sub> sensor until the end of the finger reaches the finger stop. Do not use the thumb.
2. The fingernail should face the side with the red light. Make sure that long fingernails do not interfere with proper finger position
3. An SpO<sub>2</sub> reading will be displayed after a few seconds. Remove the finger from the SpO<sub>2</sub> sensor, and the last measurement will be displayed and flashed.
4. If the sensor is not removed from the finger, SpO<sub>2</sub> readings will be automatically stopped after 10 minutes of continuous measurement, and the last measurement will be displayed and flashed.
5. To start a new measurement, re-apply the SpO<sub>2</sub> sensor to the finger as described in Step 1.

*NOTE: If the signal quality from the sensor drops below 90%, no measurement will be displayed in the SpO<sub>2</sub> section*



*SpO<sub>2</sub> , and the percent symbol % will begin flashing. Check sensor for correct placement and usage.*

### Special Notes for Masimo® SET SpO<sub>2</sub> module:

*NOTE: Possession or purchase of this device does not convey any express or implied license to use the device with unauthorized sensors or cables which would, alone or in combination with this device, fall within the scope of one or more of the patents relating to this device.*

*NOTE: If the accuracy of any measurement does not seem reasonable, first check the patient's vital signs by alternate means and then check the MS board pulse oximeter for proper functioning.*

*NOTE: A functional tester cannot be used to assess the accuracy of a Masimo pulse oximeter sensor or pulse oximeter. Using Clinical Dynamics SmartSat SpO<sub>2</sub> simulator, the device can display the entire range of SpO<sub>2</sub> values.*

Masimo® Sensors:

Before use, carefully read the M-LNCS™ DCI/DCIP sensor directions for use, which includes cleaning and disinfection instructions.

Masimo® M-LNCS™ sensors are provided non-sterile.

### Additional Masimo® Information:

In addition to the General Principles of Operation mentioned above, the Masimo® SET® MS board pulse oximeter uses the following principle:

The MS board decomposes the ratio of pulsatile absorbance (AC) to the mean absorbance (DC) at each of two wavelengths, 660 nm and 905 nm (S(660) and S(905)) into an arterial signal plus a noise component and calculates the ratio of the arterial signals without the noise:

$$S(660) = S1 + N1$$

$$S(905) = S2 + N2$$

$$R = S1/S2$$

Again, R is the ratio of two arterial pulse-added absorbance signals and its value is used to find the saturation SpO<sub>2</sub> in an empirically derived equation into the oximeter's software. The values in the empirically derived equation are based upon human blood studies against a laboratory co-oximeter on healthy adult volunteers in induced hypoxia studies.

The above equations are combined and a noise reference (N') is determined:

$$N' = S(660) - S(905) \times R$$

If there is no noise  $N' = 0$ : then  $S(660) = S(905) \times R$  which is the same relationship for the traditional pulse oximeter. The equation for the noise reference is based on the value of  $R$ , the value being sought to determine the  $SpO_2$ . The MS board software sweeps through possible values of  $R$  that correspond to  $SpO_2$  values between 1% and 100% and generates an  $N'$  value for each of these  $R$ -values. The  $S(660)$  and  $S(905)$  signals are processed with each possible  $N'$  noise reference through an adaptive correlation canceler (ACC) which yields an output power for each possible value of  $R$  (i.e., each possible  $SpO_2$  from 1% to 100%). The result is a Discrete Saturation Transform (DST™) plot of relative output power versus possible  $SpO_2$  value as shown in the following figure where  $R$  corresponds to  $SpO_2 = 97\%$ :

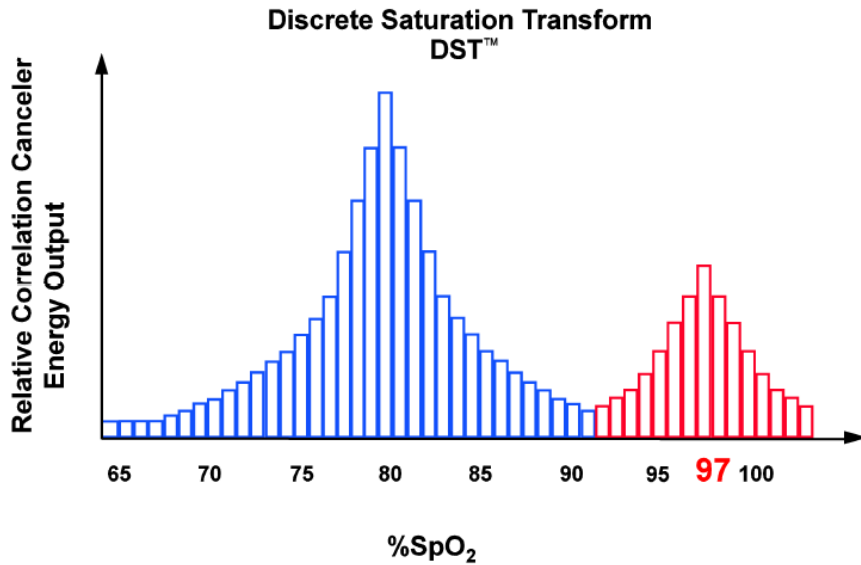

The DST plot has two peaks: the peak corresponding to the higher saturation is selected as the  $SpO_2$  value. This entire sequence is repeated once every two seconds on the most recent four seconds of raw data. The MS board  $SpO_2$  therefore corresponds to a running average of arterial hemoglobin saturation that is updated every two seconds.

**Masimo® Graphical Plot:**

Below is a graphical plot of discrete  $A_{RMS}$  values measured with Masimo® SET Oximetry in a clinical study using DCI/DCIP pulse oximetry sensors:

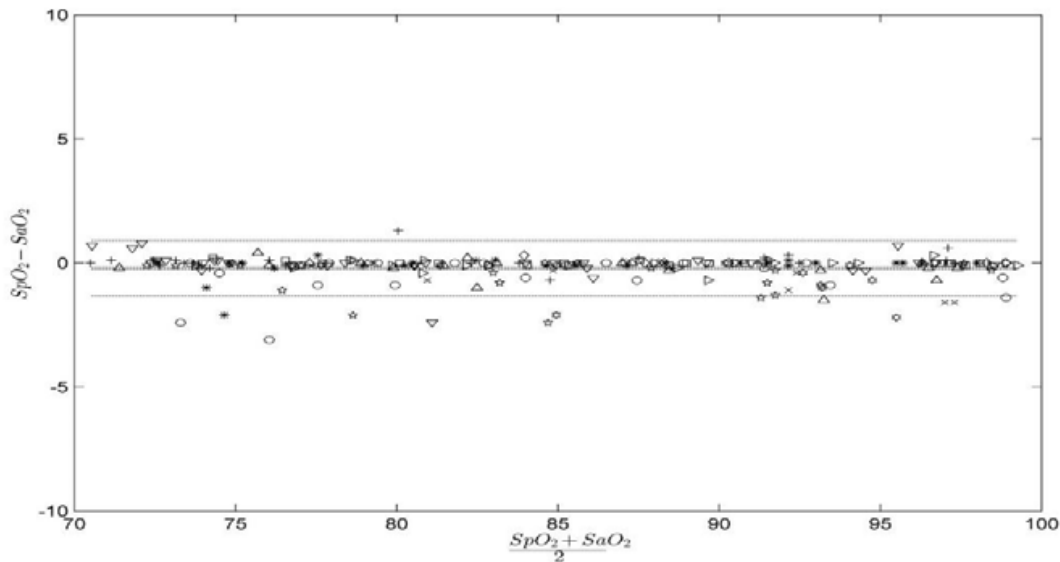

The tested device meets the stated accuracy specification of RMS Error = 2.00% for the range 70% to 100% SaO<sub>2</sub>. The accuracy is not specified below 70% SaO<sub>2</sub>. In addition, here are detailed measured A<sub>RMS</sub> values over the specified discreet ranges:

Range	A <sub>RMS</sub>
90-100%	0.60%
80-90%	0.54%
70-80%	0.67%

### Special Notes for ChipOx SpO<sub>2</sub> module:

*NOTE: Use only SpO<sub>2</sub> sensors from SunTech approved for use on the CT40 ChipOx SpO<sub>2</sub> module.*

*NOTE: A functional tester cannot be used to assess the accuracy of a ChipOx pulse oximeter sensor or pulse oximeter. Using FLUKE Biomedical Index 2 SpO<sub>2</sub> simulator, the device can display the entire range of SpO<sub>2</sub> values.*

#### ChipOx Sensors:

Before using, carefully read the ChipOx sensor directions for use, which includes cleaning and disinfection instructions.

ChipOx sensors are provided non-sterile.

#### ChipOx Graphical Plot:

Below is a graphical plot of discreet A<sub>RMS</sub> values measured with ChipOx Oximetry in a clinical study using ChipOx pulse oximetry sensors:

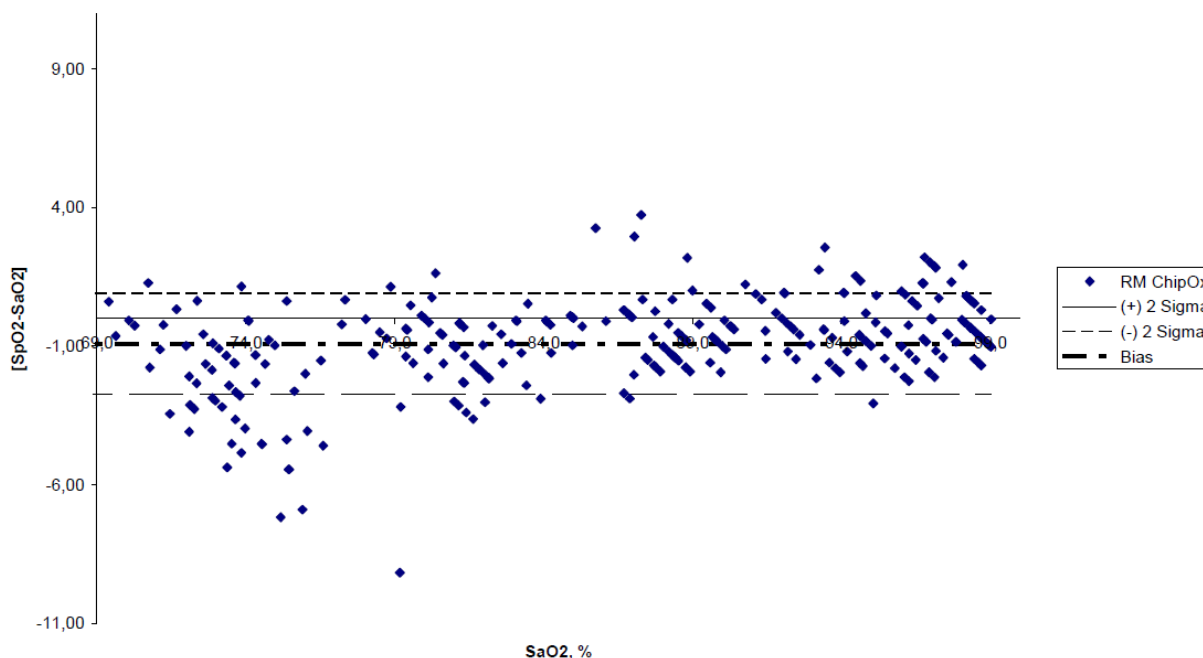

The tested device meets the stated accuracy specification of RMS Error = 1.89% for the range 70% to 100% SaO<sub>2</sub>. The accuracy is not specified below 70% SaO<sub>2</sub>. In addition, here are detailed measured A<sub>RMS</sub> values over the specified discreet ranges:

Range	A <sub>RMS</sub>
90-100%	0.60%
80-90%	0.54%
70-80%	0.67%

90-100%	1.54%
80-90%	2.10%
70-80%	2.56%

## 8. Using SunTech CT40 for Temperature Measurement

The SunTech CT40 has several options for measuring a patient's body temperature.

### Covidien® FILAC® 3000 Thermometry Module

Your device may come equipped with a Covidien® FILAC® 3000 digital thermometer capable of taking an oral, axillary (under arm) or rectal temperature reading. Your thermometer should come with a blue isolation chamber/probe unit for taking oral and axillary temperature or with a red isolation chamber/probe unit for taking rectal temperature.

*NOTE: Always apply a new probe cover before taking temperature. Do not reuse probe cover. Use only probe covers designed for use with FILAC® 3000 probes. Using the incorrect probe cover can severely damage the probe and cause measurement inaccuracies.*

*NOTE: To change between Celsius and Fahrenheit, press the °C/°F button on the FILAC® 3000 temperature module. Press again as needed.*

*NOTE: After removing the probe from the isolation chamber, the Install/Remove Probe Cover icon  will flash to remind you to apply a new probe cover. A new probe cover must be applied to take a measurement.*

After you withdraw the probe from the isolation chamber and apply a probe cover, the thermometer begins working automatically. You will see the Human Thermometry Mode icon illuminated on your display with the appropriate arrow illuminated (i.e., pointing to the mouth on right side of head for oral temperature taking). Press the Site button on your thermometer unit to switch between Oral and Axillary mode.

### Oral Temperature Taking

Insert the probe tip under the tongue on one side or the other. Ask the patient to close his mouth. Hold the probe in place until there is a long beep and the temperature reading displays.

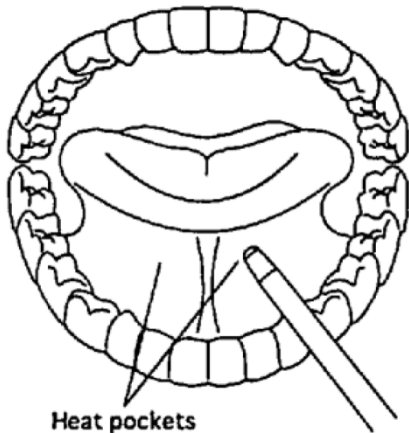

## Axillary Temperature Taking

With the patient's arm uplifted, place the probe tip into the patient's armpit, directly on the skin. Ask the patient to lower his arm and hold still. Hold the probe perpendicular to the arm until there is a long beep and the temperature reading displays.

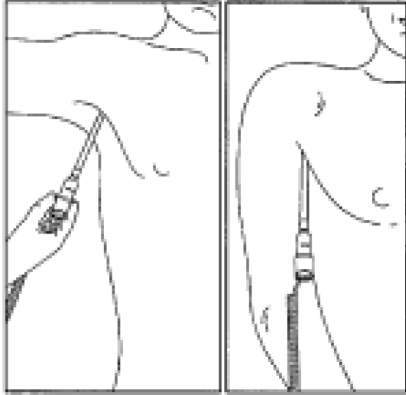

## Rectal Temperature Taking

Apply lubricant to the probe cover and insert it gently into the patient's rectum only one-half inch to three-fourth inch (12 mm to 19 mm) for adults or one-fourth to one-half inch (6 mm to 13 mm) for children. Hold the probe still until there is a long beep and the temperature reading displays.

*NOTE: If the temp probe is returned to the probe well before the "long beep" is heard, no temperature measurement will be displayed.*

*NOTE: Be sure to eject the used probe cover into an approved bio-hazard container before attempting to place the probe back in the isolation chamber.*

## Other FILAC® 3000 Temperature Settings

Your device's FILAC® 3000 thermometer operates in several different modes.

Quick Mode is an oral predictive measurement mode that provides a fast reading. Quick Mode allows you to rapidly identify patients with normal body temperatures. If the patient temperature is outside of the "normal" range, the FILAC® 3000 electronic thermometer will automatically switch into its standard predictive mode to provide a more accurate reading. Quick Mode is indicated by a rabbit icon on the display 🐰. Quick Mode is not available when in Cold Mode or in Direct Mode.

The FILAC® 3000 thermometer normally operates in predictive mode to provide fast and accurate temperature measurements. However, in instances when no measurement site is detected, or the temperature does not stabilize, the thermometer will automatically switch to Direct Mode 🐢. Additionally, the FILAC® 3000 electronic thermometer will automatically switch into Direct Mode if the ambient temperature is greater than 35°C (95°F). If this happens, you will hear two short beeps and see the Direct Mode turtle icon appear 🐢. This icon will be continuously displayed whenever the thermometer is functioning in Direct Mode. The Direct Mode auto feature is always functional for both the Red or Blue isolation chamber/probe combinations.

Cold Mode can be selected if a patient's body temperature is expected to be lower than normal, such as when he is coming out of surgery. Cold Mode is activated by pressing the Site Selection button and °C/°F button simultaneously on the temp module. When selected, the Cold Mode snowflake icon ❄️ is displayed, and the probe will preheat to 33°C (91°F). The accuracy and measurement time of Cold Mode measurements are equivalent to standard prediction measurements at the respective body sites.

## Touchless Thermometry Module\*

If your device comes with the optional touchless thermometry module, you can easily and quickly measure the patient's temperature using a touchless infrared temporal thermometer. To use, remove the thermometer from the holster on the side of the SunTech CT40. Touch the thermometer's START button to turn on the touchless thermometer.

On your SunTech CT40 display, you will see the Human Thermometry Mode icon selected with the arrow pointing to



the side of the head. Hold the thermometer probe 2 cm to 3 cm from the patient's temple and press the START button on the back of the thermometer. The reading is complete when you hear a beep, and the temperature measurement will appear on your device display. Place the thermometer back in the device holster.

*NOTE: Be sure to wipe away any sweat from the area around the temporal artery and be sure to remove eyeglasses and push hair away from measurement site before initiating a measurement.*

*NOTE: The area just behind the ear lobe can be used as an alternative measurement site to the temporal artery.*

*NOTE: The SunTech Touchless Thermometer should not be used near sources of heat or cold, such as a heater or air conditioner vent. Also, do not use outdoors. Use this product in a room where the temperature is between 16°C and 40°C (61°F and 104°F).*

*NOTE: If patients are subject to a significant change in temperature from outside to inside, the patient should be allowed to acclimate for approximately 15 minutes before using the touchless thermometer.*

*NOTE: IR temperature readings provided by this device are closely aligned to core temperatures rather than an axillary or rectal reading. Take this into account when reviewing readings.*

To change the measurement units from °C to °F or vice-versa, ensure that the thermometer is on by pressing the START button. Then press the MODE and MEM buttons on the thermometer simultaneously for 3-4 seconds.

The SunTech Touchless Thermometer can also be used to measure the temperature of an object, such as a vessel containing liquid, or food. To use Object Mode, ensure that the thermometer is turned on by pressing the START

button. Press the Mode Button briefly. The Object Mode icon  will then appear in the device display. Place the thermometer 2-3 cm from the desired measuring point on the object and press the START button. Hold thermometer in place until you hear a long beep. The temperature will be displayed on the screen.

*NOTE: Remember that surface temperature and inner temperature of an object can vary greatly.*

*\*Touchless Thermometry module is not available in all countries. Contact SunTech to find out if this feature is available in your area*

## 9. Using SunTech CT40 EMR and Memory Functions

Section 4 "Good to Know Before You Begin" provides some basic information about the SunTech CT40's EMR and memory functions. Here are more details about how these functions work.

### Barcode Scanner Setup

If your scanner was purchased from SunTech Medical Inc, they are provided, programmed for use with the CT40. If the scanner is not working with the CT40, scan the barcode below with the scanner plugged into any powered USB.



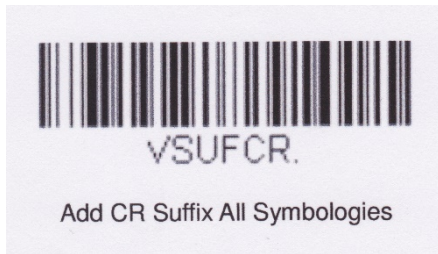

If your scanner was not purchased from SunTech Medical Inc, refer to the user manual of your scanner to ensure the scanner is programmed to provide a carriage return at the end of a reading.

## Memory Mode

When you power up the unit, the memory identifier appears at the top of the display beside the Memory Icon . This is the number that will be associated with the next set of measurement results that are sent to the device memory.

Press the Memory Button  on the front of the device to save results to memory. The Memory Icon, check mark icon and all values that are displayed on the screen (at the time the button is pressed) will flash before the results are saved. The following values can be saved to memory.

Parameter Name	Field Type
Patient ID	Alphanumeric Text
Time Stamp	Numeric, HH:MM:SS
Date Stamp	Numeric, MM.DD.YYYY or DD.MM.YYYY
Memory Location	Numeric
Systolic BP	Numeric
Diastolic BP	Numeric
BP Type	Text: AVG or SM
Pulse Rate	Numeric
Pulse Rate Source	Text: BP or SpO <sub>2</sub>
Mean Arterial Pressure	Numeric
SpO <sub>2</sub>	Numeric
Temperature	Numeric
Temperature U/M	Text: C or F
Temperature Site	Text: ORL, AXL, RCT, FHD

**NOTE:** If a parameter has no data showing at the time the memory button is pressed, then all values for that parameter will be stored as 'null'.

To recall measurements from memory:



Press and hold the Memory Button  for four seconds on the front of the device.

You will then be able to use the Selection knob to scroll through prior readings

Press the Memory Button or the Home Button to exit memory mode.

### Clearing Measurements from Memory

To clear a single measurement from memory:



Press the Selection Knob while in memory mode. The Memory Delete icon  and the Check icon  will flash, along with the Memory Identifier number.

Ensure you are viewing the measurement you wish to delete.

Press the Selection Knob to delete that measurement. Or rotate the knob clockwise until the X icon  flashes and press the Selection Knob to cancel the deletion.

To clear all measurement values from memory:

While in Memory Mode, press and hold the Memory Button for less than three seconds, and while holding, then press the Selection Knob.

The Memory Delete icon  and Check icon  will flash in sync with the Selection Knob. All other values on the screen will be blank.

Press the Selection Knob again to delete all measurements or rotate the knob clockwise until the X icon  flashes and press the Selection Knob to cancel the deletion.

### EMR Transmissions

Section 4 covers the basics of sending measurements to EMR. Here are more details.

#### Validating Patient ID with EMR





Scan the patient's barcode ID with your barcode scanner. If your SunTech CT40 is connected to an EMR, a verification query will automatically be sent to the EMR to confirm the validity of the patient ID. If the EMR responds that the patient ID is valid, then the patient ID icon, field values and Check Icon  will flash four times.



If the EMR responds that the Patient ID is invalid, then the Patient icon field, field values and X icon will flash six times and a message will appear in the Patient ID field indicating that the Patient ID entered is not valid.



*NOTE: The Patient ID must be validated by the EMR before any vital signs measurements can be sent to the EMR.*

#### Sending Measurements to EMR

Sending measurements to an EMR will work only if your SunTech CT40 has been configured to connect to an EMR.

After scanning a valid Patient ID, and taking vital signs measurements, press the Memory Button . The EMR icon **EMR** and Check Mark Icon  will start flashing. Press the Selection Knob to send the data to the EMR. If the measurements are delivered to the EMR successfully, you will see the EMR Message Icon  and the Check Mark Icon  flash four times.

If the EMR has a problem receiving the measurements, the EMR Message icon  and X icon  will flash eight times and you will hear 4 short beeps. You will see a message indicating the nature of the problem, such as:

“Rejected” or “Rejected for an error.” This message occurs when the device is connected to the network but the EMR rejects the message. A corresponding message will appear in the Patient ID field during a three-second period when the Message Icon  and X icon  flash on and off.

“No response (time out).” This message occurs when the device is connected to the network but the EMR is not responding. It also can occur if network connectivity is lost. If there is a network connection, the SunTech CT40 will continue to try to transmit the message every 10 seconds. A message in the Patient ID field will alert you that another attempt to send the message will be made in 10 seconds. If network connectivity is lost, you will see a corresponding message in the Patient ID field, and the device will continue trying to reestablish a connection and send the measurements at intervals set during EMR setup. If problems persist, you may wish to contact your facility’s information technology department. As a backup, the patient’s measurements are saved in the device memory when the memory button was pressed and can be retrieved using the procedure detailed in the beginning of Section 9.

*Note: After the memory button is pressed, all values to be stored to memory will flash off and on twice, along with the check mark icon, memory icon and memory location identifier. After flashing, the display will revert to null values for the patient ID and all measurement data, and the check mark icon will flash off and on twice more.*

## 10. Taking Care of SunTech CT40

### Cleaning

 **CAUTION:** The SunTech CT40 is not sterilizable. Do not immerse the monitor in any fluid or attempt to clean with any liquid detergents, cleaning agents, or solvents.

Dampen a soft cloth with mild medical grade disinfectant and wipe the device to remove surface dust and dirt. Dry surface thoroughly before use.

### SpO<sub>2</sub> Sensors and Thermometers

 **CAUTION:** Never immerse sensors, clips or thermometers in fluids. Do not pour or spray any liquids onto the sensor or thermometers. Caustic or abrasive cleaners will cause permanent damage. Do not open the case of the SpO<sub>2</sub> sensor finger clip sensor more than 45° or the case will be damaged.

Clean the SpO<sub>2</sub> sensor and thermometers with a soft cloth dampened with a mild medical grade disinfectant or isopropyl alcohol. Remove all tape residues. Allow the sensor and thermometer to dry thoroughly before reusing.

### Preventative Maintenance

#### System Self Checks

The SunTech CT40 performs a range of system checks during normal operation. If the device detects a problem, it will display an error code.

#### Replaceable Parts

On a routine basis, inspect the monitor, cuffs and hoses for cracks, fraying, or kinks. Immediately replace any damaged part. Refer to the list of Accessories & Replacement Parts in this guide.

## Replacing and Disposal of the Battery



**CAUTION:** Fire, explosion and severe burn hazard. Replace only with SunTech part number: 17-0022-00

When the battery no longer charges, or it needs excessive recharging, it may need to be replaced. See the “Installing Battery” section above for proper installation and precautions to be taken when installing the rechargeable battery. Please dispose of the old battery per the instructions below.

## Battery Disposal



■ The SunTech CT40 device contains a lithium ion battery that contains materials which may be hazardous to human health. Do NOT dispose of battery in domestic waste! Instead, please dispose of in an environmentally responsible way, or return the battery to SunTech Medical. A prepaid return label can be obtained. Please see our website for more information about our environmental policy at <http://www.suntechmed.com/about-suntech/environmental-policy>

## Product Disposal



■ Do not dispose of this product as unsorted municipal waste. Prepare this product for reuse or separate collection as specified by Directive 2002/96/EC of the European Parliament and the Council of the European Union on Waste Electronic and Electrical Equipment (WEEE).

## Cuff Disposal



■ Do not return used cuffs. Used blood pressure cuffs may be contaminated medical waste and should be dealt with in accordance to your local regulations.

## Routine Calibration

Have the SunTech CT40 blood pressure function checked every two years to verify the accuracy of the pressure transducers and indicators. Please have this done by a biomedical technician or SunTech Customer Service.



**CAUTION:** Calibration should be done by a biomedical technician or other person familiar with the SunTech CT40 device.

If a biomedical technician performs this function, they should contact SunTech Medical for instructions to access “Verify Calibration”. Instructions are also available in the SunTech CT40 service manual (SunTech Part 80-0068-XX-SM).

For customers in the Americas:



SunTech Medical, Inc.  
Service Department  
507 Airport Boulevard, Suite 117  
Morrisville, NC 27560 USA  
Tel: 800.421.8626  
919.654.2300  
Fax: 919.654.2301

For customers in Europe, the Middle East, Africa, Asia, and the Pacific:



SunTech Medical, Ltd.  
Service Department  
Oakfield Industrial Estate  
Eynsham, Oxfordshire OX29 4TS UK  
Tel: 44 (0) 1865.884.234  
Fax: 44 (0) 1865.884.235

## 11. Accessories & Replacement Parts

Contact your SunTech Medical sales representative to purchase the following items:

### Main Unit

Part Number	Description	Details
91-0028-16	10'/3.0m Patient BP Hose, Bayonet to Bayonet	Each
98-0600-41	OPD Child (12-19cm) BP Cuff, Bayonet	Box 5
98-0600-43	OPD Small Adult (17-25cm) BP Cuff, Bayonet	Box 5
98-0600-45	OPD Adult (23-33cm) BP Cuff, Bayonet	Box 5
98-0600-4A	OPD Adult Plus (28-40cm) BP Cuff, Bayonet	Box 5
98-0600-47	OPD Large Adult (31-40cm) BP Cuff, Bayonet	Box 5
98-0600-4C	OPD Large Adult Plus (40-55cm) BP Cuff, Bayonet	Box 5
98-0600-49	OPD Thigh (38-50cm) BP Cuff, Bayonet	Box 5
91-0003-00	AC Power Cord, Americas	Each
91-0003-05	AC Power Cord, Europe	Each
91-0003-06	AC Power Cord, UK	Each
91-0100-02	Mini-USB to USB Cable	Each
17-0022-00	Battery, 18650 Li-ion pack, 7.26V 6.6Ah, Rechargeable	Each

### Masimo® SET SpO<sub>2</sub> Module

Part Number	Description	Details
(*)	Masimo® M-LNCS DCI Adult SpO <sub>2</sub> Reusable Sensor, 2501	Each
(*)	Masimo® M-LNC 10'/3.0m Patient Cable, 2525	Each

(\*) *contact your local Masimo® distributor to purchase*

## ChipOx (Nellcor® Compatible) SpO<sub>2</sub> Module

Part Number	Description	Details
52-0010-00	Reusable Adult SpO <sub>2</sub> Finger Sensor, ChipOx	Each

## Covidien® FILAC® 3000 Temperature Module

Part Number	Description	Details
52-0009-00	F3000 Oral/Axillary Temp Probe, 9'	Each
45-0006-00	F3000 Oral/Axillary Isolation Chamber, Blue	Each
52-0009-01	F3000 Rectal Temp Probe, 9'	Each
45-0006-01	F3000 Rectal Isolation Chamber, Red	Each
98-0131-01	F3000 Disposable Temp Probe Covers (25 boxes/tray, 20 covers/box)	1 tray
98-0130-01	F3000 Disposable Temp Probe Covers (25 boxes/tray, 20 covers/box)	10 trays

## Touchless IR Temperature Module

Part Number	Description	Details
98-0412-00	Replacement IR Thermometer with cable	Each

## Stands/Printer/Scanner

Part Number	Description	Details
46-0040-00	Deluxe Mobile Stand	Each
46-0040-01	Mobile Stand Printer Mount	Each
98-0256-00	CT40 Thermal Printer (w/USB, paper)	Each
45-0005-00	CT40/50 WIFI Dual Band USB Dongle	Each
71-0543-00	Thermal Printer Paper	Each
98-0257-03	Barcode Scanner, 1D	Each
98-0257-04	Barcode Scanner, 2D	Each

## Alternate Functional Scanners

\*These accessories are tested to work with the SunTech CT40, but are not sold or supported by SunTech Medical Inc. To work with the SunTech CT40, these barcode scanners must be programmed to provide a carriage return suffix at the end of a scan.

Model Number	Description	Details
DS4308HC	Zebra, 2D Medical Grade Barcode Scanner	Each
HS-1M	Jadak, 2D Medical Grade Barcode Scanner	Each
FG2100	Farsun, 1D Point of Sale Grade Barcode Scanner	Each
CM-880	Canmax, 1D Point of Sale Grade Barcode Scanner <sup>1</sup>	Each
1900HHD-5-INT	Honeywell, 2D Medical Grade Scanner	Each

1. This product is EOL. Canmax recommends CM-890

## 12. Status Messages & Alarms

If the SunTech CT40 has a problem taking a measurement, you may see a code on the display screen.

The  icon will blink with the respective measurement display result; (i.e blood pressure, SpO<sub>2</sub>, Temperature), while displaying the code.

Below are common error codes. Take action as directed on the screen, or as suggested in the table below.

### Status Messages

Code Displayed	Action User Should Take
<b>Blood Pressure:</b>	
1-2, 4, 87 & 88	<p>Check the cuff is in the correct position.</p> <p>Check that the cuff is properly tightened, and tubing properly connected.</p> <p>Check that there is no excessive clothing between the arm and cuff.</p> <p>Check that the cuff applied is the correct size.</p> <p>The patient may have been moving too much.</p> <p>Take another BP reading.</p>
3	No action possible. Values are outside the reportable range.
85 & 89	<p>Check that the hose has no sharp bends and is not pinched.</p> <p>Check that the patient is not lying on the cuff.</p> <p>Check that the cuff is in the correct position.</p> <p>Take another BP reading.</p>
86	If cancelled reading was unintended, allow cuff to deflate & restart reading.

	If cancelled reading was intended, no action needed.
90, 91, 97-107	Power off and repower on the CT40. If issue persists, call SMI Customer Service. Service Required
<b>Temperature:</b>	
505 & 506	Touchless: Make sure patient has been at rest for a few minutes. If patient has been in cold environment, make sure patient has acclimated to indoor temperature FILAC®: Make sure patient has not had any warm beverages recently (oral), and then retry measurement.
501-504, 507-514, 516-517	Remove and then replace the probe in the well. Retry reading. Power off and repower on the CT40. Retry reading. If issue persists, call customer service.
520-524 & 526	Power off and repower on the CT40. Retry reading. If issue persists, replace the probe. Retry reading. If issue persists, replace module or call Customer Service.
530	Use in normal room temperature environment suitable to the device.
<b>SpO<sub>2</sub>:</b>	
121-124, 133-136, 150-156	Remove sensor from the patient and ensure proper positioning. Attempt new measurement ensuring proper protocol as in section 7 of the User Manual. Unplug sensor and reconnect. If issue persists, power off and repower on the CT40. Retry reading. If issue persists, call Customer Service.
126-132	Power off and repower on the CT40.
137-149 & 157-192	If issue persists, replace module or call Customer Service
<b>Electronic Medical Records (EMR):</b>	
601-610 & 612,614	Check EMR Configuration, check wireless strength and proximity. Call biomedical engineer or IT support.
611	Ensure proper barcode and Patient ID scanned.
613	Multiple patients have the same patient ID.



### CT40 System:

300-302 Power off and repower on the CT40.

341-344 Power off and repower on the CT40.  
Return for Service.

### Powering Device:

201 Run only from A/C power source.  
Have battery service performed at earliest convenience.

202 Power off and repower on the CT40.  
If repower attempt does not work, plug in power source and power off and repower on CT40 again.  
Retry reading. If issue persists, call Customer Service.

203-211 Clear the error and power off and repower on the CT40.  
Replace battery.

212-214 Call Customer Service.

215 Charge Battery.

### Barcode Scanner:

701-706 Check and insure proper barcode and Patient ID was scanned  
Rescan Patient ID  
Disconnect / Reconnect cable from USB port on CT40.  
Replace Barcode Scanner

### Printing:

381 Close Printer Door.

382 Replace Paper.

383- 387 & 388-390 Check cables. Reset Printer. Replace Printer.

## Out of Range Measurements

The SunTech CT40 can measure BP that falls within the following ranges.

**Systolic:** Adult 40-260 mmHg, Pediatric 40-230 mmHg

**Diastolic:** Adult 20-200 mmHg, Pediatric 20-160 mmHg

**Heart Rate:** 30 - 220 BPM

The SunTech CT40 will display temperature and SpO<sub>2</sub> within the following ranges.

**FILAC® Temperature:** 30.1 to 42.9 °C (86.2 – 109.2 °F)

**Touchless IR Temperature:** 34 to 42.5 °C (93.2 – 108.5 °F)

**SpO<sub>2</sub>**: 70 – 100%

If measurement is above or below specified ranges:

Single measurement mode: The highest or lowest possible threshold range will blink in the appropriate BP measurement field.

Averaging mode:  will blink in addition to the status code “3” in the blood pressure measurement display

Temperature: depending on the out of range value, the display will indicate whether the value is out of range (hi) or out of range (Lo).

SP02: results falling below the measurement range will display “Lo” in the results field.

## Service Centers

For customers in the Americas, Asia, and the Pacific:



SunTech Medical, Inc.  
Service Department  
507 Airport Boulevard, Suite 117  
Morrisville, NC 27560 USA  
Tel: 800.421.8626  
919.654.2300  
Fax: 919.654.2301

For customers in Europe, the Middle East, and Africa:



SunTech Medical, Ltd.  
Service Department  
Oakfield Industrial Estate  
Eynsham, Oxfordshire OX29 4TS UK  
Tel: 44 (0) 1865.884.234  
Fax: 44 (0) 1865.884.235

## 13. Frequently Asked Questions

### What is the expected battery life for the SunTech CT40?

When batteries are fully charged, the SunTech CT40 is designed to run on internal battery power for 120 measurement cycles (BP, temperature and SpO<sub>2</sub> measurements) before requiring recharge. When only the bottom segment of the battery symbol is illuminated, there is between 11 percent and 40 percent battery power remaining.

### Will the device automatically power down?

When no measurements have been taken or buttons pressed for one hour, the device will automatically power-down and enter the low-power state and is considered “off.”

### What is the significance of different beeps I hear during operation?

One long beep (approximately 3-second beep): Successful end of BP measurement.

Three long beeps: Severe hardware error.

One short beep (1-second beep): Power-up or Power-down complete.

Four short beeps: There has been an error.

If you abort a BP measurement by pressing the Start/Stop button, you will hear one short beep. Then after the pressure has been completely dumped from the cuff, you will hear one long beep.

#### **Can pulse oximetry, temperature measurement, a barcode scanner or printer be added later too?**

Yes, you can add vital signs modules and accessories to the SunTech CT40 at any time.

#### **Can EMR connectivity be established at a later date if not enabled as part of initial configuration?**

Yes, EMR settings can be accessed via the Advanced Configuration Application at any time.

#### **Why is no heart rate data showing on the display?**

If the device is configured to use the SpO2 sensor as the pulse rate source, and the sensor is not attached to the patient, there will not be heart rate data on the display. Only dashes will appear, or MAP results if MAP measurement is enabled. Note that MAP is not available in the United States.

#### **How many measurements can be stored in the SunTech CT40 memory?**

The SunTech CT40 can store 99 unique sets of measurements. After the 99<sup>th</sup> measurement has been saved, the next measurement will have the Memory Location Identifier label "01" and will overwrite the most recent measurement (measurement 99). After all results are cleared from the memory, the Memory Location Identifier also will return to "01."

## **14. Technical Information**

### **EMC Statement**

This equipment needs special precautions regarding EMC and needs to be installed and put into service according to the EMC information provided in this document. This equipment has been tested and found to comply with the limits for medical devices to IEC60601-1-2: 2014. These limits are designed to provide reasonable protection against harmful interference in a typical medical installation. This equipment generates, uses and can radiate radio frequency energy and, if not installed and used in accordance with the instructions, may cause harmful interference to other devices in the vicinity. However, there is no guarantee that interference will not occur in a particular installation. When the device accuracy of any value displayed on the monitor is questionable, determine the patient's vital signs by alternative means. If it is determined that the device is malfunctioning, stop using the device and have the device checked by a qualified service technician before further use. If this equipment does cause harmful interference to other devices, which can be determined by turning the equipment off and on, the user is encouraged to try to correct the interference by one or more of the following measures:

Reorient or relocate the receiving device.

Increase the separation between the equipment.

Connect the equipment into an outlet on a circuit different from which the other device(s) are connected.

Consult the manufacturer or field service technician for help.

Portable and mobile RF communications equipment can affect Medical Electrical Equipment.

**WARNING:** Portable RF communications equipment (including peripherals such as antenna cables and external antennas) should be used no closer than 30 cm (12 inches) to any part of the CT40 system, including cables specified by the manufacturer. Otherwise, degradation of the performance of this equipment could result.

**WARNING:** Use of accessories, transducers, and cables other than those specified may result in increased emissions or decreased immunity of the CT40.

**WARNING:** The CT40 should not be used adjacent to or stacked with other equipment. If adjacent or stacked use is necessary, the CT40 should be observed to verify normal operation in the configuration in which it will be used.

<b>Guidance and Manufacturer's Declaration – Electromagnetic Emissions</b>		
<p>The CT40 Monitor is intended for use in a Professional Healthcare Facility within the electromagnetic environment specified below. The customer or the user of the CT40 Monitor should assure that it is used in such an environment. This equipment has been tested and found to comply with the limits for medical devices to IEC60601-1-2: 2014.</p>		
<b>Emissions test</b>	<b>Compliance</b>	<b>Electromagnetic Environment – Guidance</b>
RF emissions CISPR 11	Group 1	<p>The CT40 Monitor uses RF energy only for its internal function. Therefore, its RF emissions are very low and are not likely to cause any interference in nearby electronic equipment.</p>
	Class B	
Harmonic emissions IEC 61000-3-2	Class A	<p>The CT40 Monitor is suitable for use in all establishments other than domestic and those directly connected to the public low-voltage power supply network that supplies buildings used for domestic purposes.</p>
Voltage fluctuations/ flicker emissions IEC 61000-3-3	Complies	

<b>Guidance and Manufacturer's Declaration – Electromagnetic Immunity</b>			
<p>The CT40 Monitor is intended for use in a Professional Healthcare Facility within the electromagnetic environment specified below. It is not intended for helicopter transport, hospital ambulance or home use. It is not intended for near active HF SURGICAL EQUIPMENT and the RF shielded room of an ME SYSTEM for magnetic resonance imaging, where the intensity of EM DISTURBANCE is high. The customer or the user of the monitor should assure that it is used in such an environment. This equipment has been tested and found to comply with the limits for medical devices to IEC 60601-1-2: 2014.</p>			
<p>In the event of an error, the device will auto-recover within 5 seconds.</p>			
<b>Immunity Test</b>	<b>Applies to</b>	<b>Compliance Level</b>	<b>Electromagnetic Environment- Guidance for Professional Healthcare Facility Environment</b>
Electrostatic discharge (ESD) IEC 61000-4-2	All device input and output connections and cables.	<p>± 2, 4, 6, 8kV contact  ± 2, 4, 8, 15kV air discharge</p>	<p>Floors should be wood, concrete or ceramic tile. If floors are covered with synthetic material, the relative humidity should be at least 30%. Users must eliminate static in their hands before use it.</p>

**Guidance and Manufacturer's Declaration – Electromagnetic Immunity**

Radiated RF EM fields IEC 61000-4-3	All device input and output connections and cables.	3V/m 80 MHz to 2700MHz 80% AM at 1kHz	Radiated electromagnetic fields should be at levels characteristic of a typical location in a typical commercial or hospital environment
Radiated RF Wireless communication equipment IEC 61000-4-3	All device input and output connections and cables.	See Table A below	This device has been subjected to RF wireless communication bands from cell phones, and other communication devices
Electrical fast transient/burst IEC 61000-4-3	All device input and output connections and cables.	± 2kV for power supply lines 100kHz repetition frequency	Mains power quality should be that of a typical commercial or hospital environment (Professional Healthcare Facility)
Surge IEC 61000-4-5	All device input and output connections and cables.	± 0.5, 1, 2kV	
	All device input and output connections and cables.	± 0.5, 1kV	
Conducted Disturbances induced by RF fields IEC 61000-4-6	All device input and output connections and cables.	3V 0.15MHz – 80MHz 6V in ISM bands between 0,15 MHz and 80MHz 80% AM at 1kHz	Mains power quality should be that of a typical commercial or hospital environment. All handheld and patient coupled parts should be consistent with intended use.
	DC Input and all cables	(>3m)	
Power Frequency magnetic field IEC 61000-4-8	All device input and output connections and cables.	30 A/m 50 or 60 Hz	Power Frequency magnetic fields should be at levels characteristic of a typical location in a typical commercial or hospital environment.
NOTE: a) $U_T$ is the a.c. mains voltage prior to application of the test level b) E.g. 25/30 means 25 periods at 50 Hz or 30 periods at 60 Hz			
Voltage dips, short interruptions and voltage variations on power supply input lines IEC 61000-4-11	Device input (AC power)	0% $U_T$ : 0.5 cycle <sup>a)</sup> At 0°, 45°, 90°, 135°, 180°, 225°, 270° and 315°	Mains power quality should be that of a typical commercial or hospital environment (Professional Healthcare Facility)
		0% $U_T$ : 1 cycle 70% $U_T$ : 25/30 cycles <sup>b)</sup> Single Phase: at 0°	If the user of the monitor requires continued operation during power mains interruption, it is

**Guidance and Manufacturer's Declaration – Electromagnetic Immunity**

		0% U <sub>T</sub> : 250/300 cycles b)	recommended that the monitor be powered from an uninterruptible power supply or a battery.
Conducted RF IEC 61000-4-6	All device input and output connections and cables.	3V 10V ISM bands 150kHz to 80MHz	Portable and mobile RF communications equipment should be used no closer to any part of the monitor including cables, than the recommended separation distance calculated from the equation applicable to the frequency of the transmitter. Minimum separation distance for higher IMMUNITY TEST LEVELS shall be calculated using the following equation.
			Where P is the maximum output power rating of the transmitter in watts (W) according to the transmitter manufacturer and d is the recommended separation distance in meters (m) and E is the Immunity Test Level in V/m.
			$E = \frac{6}{d} \sqrt{P}$
			Field strengths from fixed RF transmitters, as determined by an electromagnetic site survey, a should be less than the compliance level in each frequency range

Rated maximum output power of transmitter. Watts (W)	Separation distance according to frequency of transmitter meters (m)		
	150 kHz to 80 MHz $d = 1,2\sqrt{P}$	80 MHz to 800 MHz $d = 1,2\sqrt{P}$	800 MHz to 2,5 GHz $d = 2,3\sqrt{P}$
0.01	0.12	0.12	0.23
0.1	0.38	0.38	0.73
1	1.2	1.2	2.3
10	3.8	3.8	7.3
100	12	12	23

For transmitters rated at a maximum output power not listed above, the recommended separation distance d in meters (m) can be estimated using the equation applicable to the frequency of the transmitter, where P is the maximum output power rating of the transmitter in watts (W) according to the transmitter manufacturer.

NOTE 1: at 80 MHz and 800 MHz, the separation distance for the higher frequency range applies.  
 NOTE 2: These guidelines may not apply in all situations. Electromagnetic propagation is affected by absorption and reflection from structures, objects and people.

- a) Field strengths from fixed transmitters, such as base stations for radio (cellular/cordless) telephones and land mobile radios, amateur radio, AM and FM radio broadcast and TV broadcast cannot be predicted theoretically with accuracy. To assess the electromagnetic environment due to fixed RF transmitters, an electromagnetic site survey should be considered. If the measured field strength in the location in which the monitor is used exceeds the applicable RF compliance level above, the monitor should be observed to verify normal operation. If abnormal performance is observed, additional measures may be necessary, such as reorienting or relocating the monitor.
- b) Over the frequency range 150kHz to 80 MHz, field strengths should be less than 3V/m

**Table A – Test specifications for the device’s Signal Input Parts/Signal Output parts to RF wireless communication equipment.**

Test Frequency (MHz)	Band a) (MHz)	Service b)	Modulation b)	Maximum Power (W)	Distance (m)	IMMUNITY TEST LEVEL (V/m)
358	380 – 390	TETRA 400	Pulse Modulation b) 18Hz	1,8	0.3	27
450	430 – 470	GMRS 460, FRS 460	FM c) 5 kHz deviation 1 kHz sine	2	0.3	28
710	704 - 787	LTE Band 13, 17	Pulse Modulation b) 217Hz	0,2	0.3	9
745						
780						
810	800 - 960	GSM 800/900, TETRA 800, iDEN 820, CDMA 850, LTE Band 5	Pulse Modulation b) 18Hz	2	0.3	28
870						
930						
1720	1700 - 1990	GSM 1800, CDMA 1900, GSM 1900, DECT, LTE Band 1, 3, 4, 25, UMTS	Pulse Modulation b) 217Hz	2	0.3	28
1845						
1970						
2450	2400 - 2570	Bluetooth, WLAN, 802.11 b/g/n, RFID 2450, LTE Band 7	Pulse Modulation b) 217Hz	2	0.3	28
5240	5100 – 5800	WLAN 802.11 a/n	Pulse Modulation b) 217Hz	2	0.3	9
5500						
5785						

NOTE If necessary to achieve the IMMUNITY TEST LEVEL, the distance between the transmitting antenna and the ME EQUIPMENT or ME SYSTEM may be reduced to 1m. The 1m test distance is permitted by IEC 61000-4-3

- a) For some services, only the uplink frequencies are included  
 b) The carrier shall be modulated using a 50% duty cycle square wave signal  
 c) As an alternative to FM modulation, 50% pulse modulation at 18 Hz may be used because while it does not represent actual modulation, it would be worst case.



## Specifications, General

Conditions for Use:	Operating: 10°C (50°F) to 40°C (104°F) 15 – 90% RH non-condensing - 70 kPa - 106 kPa. Operating the monitor in an environment at maximum temperature can produce temperatures exceeding 41°C (41.6°C highest recorded) on a patient applied part. It is up to the operator to determine if this temperature is too high based upon the condition of a patient and, if so, to ensure the ambient temperature of the environment is 38°C or below.	
Storage:	-20°C (-4°F) to 55°C (131°F) 15 – 90% RH non-condensing - 50 kPa - 106 kPa. Performance can be affected if, used or stored outside the specified temperature, humidity, or altitude listed in the ranges above.	
Power:	Internal power supply. Input: 100-240 VAC @ 1.5A max, 50-60 Hz. Output +9VDC @ 5A IEC 320 type input connector.	
Calibration:	The accuracy of cuff - pressure transducers/indicators should be verified bi-annually.	
Safety Systems:	Independent hardware over-pressure circuit and redundant software overpressure algorithm to limit cuff pressure to less than 300 mmHg (+20/-10mmHg). Independent hardware timing circuit and redundant software timer algorithm to limit the duration of a blood pressure cycle to less than 180 seconds.	
Dimensions:	Size (without thermometer option): 8" x 6.75" x 5.2"	
Standards:	ANSI/AAMI ES60601-1:2005/(R)2012 and A1:2012, C1:2009/(R)2012 and A2:2010/(R)2012, EN 60601-1:2006/A1:2013, IEC 60601-1-2: 2014, IEC 80601-2-30: 2013, ISO 80601-2-61: 2011, ISO 15223-1:2016 ISO 10993-1, 2009, ISO 10993-5, 2009, EN ISO 10993-10, 2010, ISO 81060-2:2013, EN 50419: 2006, EN ISO 14971:2012CSA C22.2 No. 60601-1, EN ISO 81060-1: 2012, IEC 60601-1-6: 2013	
Classifications:	Equipment Classification: Class IIa per MDD, Class II (Electrical Shock), Continuous mode of operation, CE (413)	
Ingress of liquid	Ingress Protection: IPX1 for BP and SpO <sub>2</sub> modules. IPX0 for temperature modules (no protection of ingress to liquids).	
Weight	0.6 lbs. (284) gm	

## Specifications, Blood Pressure Measurement

Measurement:	Oscillometric with step deflation	
Range:	Pressure: Diastolic: 20-200 mmHg (adult), 20-160 mmHg (pediatric). Systolic: 40-260 mmHg (adult), 40-230 mmHg (pediatric)	Heart Rate: 30-220 BPM (beats per minute)
Accuracy (BP):	Meets or exceeds ANSI/AAMI/ISO 81060-2:2013 standard for noninvasive accuracy ( $\pm 5$ mmHg mean error with 8mmHg standard deviation).	

## Notes on Blood Pressure Data

Any blood pressure reading can be affected by the measurement site, the position of the patient, exercise, or the patient's physiologic condition. Environmental or operational factors which can affect the performance of the device and/or its blood pressure reading are pacemakers and common arrhythmias such as atrial or ventricular premature

beats or atrial fibrillation, arterial sclerosis, poor perfusion, diabetes, age, pregnancy, pre-clampsia, renal diseases, patient motion, trembling, and shivering.

## SP0<sub>2</sub> Sensor Specifications

Function	ChipOx <sup>®</sup>	Masimo <sup>®</sup> M-LNCS DCI
Saturation Normal (no motion)	± 2% (70-100%A <sub>rms</sub> )	± 2% (70-100%A <sub>rms</sub> )
Saturation Motion	N/A	± 3% (70-100%A <sub>rms</sub> )
Low Perfusion	N/A	SpO <sub>2</sub> +/-2%
Pulse Heart rate	20-300 BPM: ±3 BPM	± 3% BPM
Pulse Heart rate w/motion	20-300 BPM: ±3 BPM	± 5% BPM
Wavelength & Output Power	RED: 660nm @ 3.5-4.5mW IR: 905nm @ 3.5-4.5mW	RED: 660nm @ ≤ 15mW IR: 905nm @ ≤ 15mW

For more detailed information, see the instructions for use included with each device.

## Temperature Sensor Specifications

Function	Touchless IR Thermometer	Covidien <sup>®</sup> Electronic Thermometer
Temperature accuracy	Body Temperature:	30.1 to 42.9 °C (86.2 – 109.2 °F)
	36 to ~39°C	± 0.2°C
	96.8 to 102.2 °F	± 0.2°C
	34.0 to ~35.9°C	± 0.3°C
	93.2 to ~96.6 °F,	
	39.1 to ~42.5°C	± 0.3°C
	102.4 to ~108.5 °F	
Response Time	< 2 seconds	3-10 sec (Oral Quick Mode) 6-10 (Oral Standard Mode) 8-12 sec. (Axillary Mode) 10-14 sec. (Rectal Mode) 60-120 sec. (Direct Mode all sites)
Resolution	0.1°C	0.1°C

## Wi-Fi Dongle Specifications

Function	Operating Band(s)	D-Link DWA-171
Frequency	Frequency Band	Max. Output Power
5 G	5.15 – 5.25 GHz	200 mW

2.4 G	5.25 – 5.35 GHz	200 mW
	5.47 – 5.725 GHz	1 W
	2.4 – 2.4835 GHz	100 mW
Standards	802.11ac/n/g/a/b	

## Limited Warranty

SunTech Medical, Inc. provides to the original purchaser the following limited warranty from date of invoice.

Main unit, SpO <sub>2</sub> modules, temp modules	Three years
OPD Blood Pressure Cuffs	Two years
Accessories (SpO <sub>2</sub> sensors, temp probes, BP hose, etc.)	90 days

SunTech Medical, Inc. warrants each instrument to be free from defects in material and workmanship. Liability under this warranty covers servicing of the instrument when returned from the customer's facility within the United States prepaid to the factory. SunTech Medical, Inc. will repair any component(s) or part(s) that it finds to be defective during the period of this limited warranty. Should a defect become apparent, the original purchaser should first notify SunTech Medical, Inc. of the suspected defect. The device should be carefully packaged and shipped prepaid to:



SunTech Medical, Inc.  
 Service Department  
 507 Airport Boulevard, Suite 117  
 Morrisville, NC 27560 USA  
 Tel: 800.421.8626  
 919.654.2300  
 Fax: 919.654.2301



SunTech Medical, Ltd.  
 Service Department  
 Oakfield Industrial Estate  
 Eynsham, Oxfordshire OX29 4TS UK  
 Tel: 44 (0) 1865.884.234  
 Fax: 44 (0) 1865.884.23

The device will be repaired in the shortest possible time and returned prepaid by the same shipping method as received by the factory. This limited warranty is void if the device has been damaged by accident, misuse, negligence, act of God or serviced by any person not authorized by SunTech Medical, Inc. This limited warranty contains the entire obligation of SunTech Medical, Inc. and no other warranties expressed, implied or statutory are given. No representative or employee of SunTech Medical, Inc. is authorized to assume any further liability or grant any further warranties except as herein.

## Conflict Minerals

SunTech's current Conflict Minerals Statement can be accessed at:

<https://www.suntechmed.com/support/additional-resources/1918-conflict-minerals-statement>