

Stress BP



SunTech® *Tango* M2 STRESS BP



Automated Blood Pressure Monitor for Cardiac Stress and Exercise Testing User Manual

Changes

This manual is identified as Part number: 80-0055-00 Rev. E. An updated version may be available for download from the SunTech Medical website. Should you notice errors or omissions in this manual, please notify us at:

SunTech Medical, Inc.
507 Airport Boulevard, Suite 117
Morrisville, NC 27560 USA
Tel: 800.421.8626
919.654.2300
Fax: 919.654.2301
Email: CustomerService@SunTechMed.com
Web: www.SunTechMed.com

Copyright Information

All content in this manual is the proprietary information of SunTech Medical and is provided solely for purposes of operation, maintenance or service of the Tango M2. This manual and the Tango M2 described in it are protected under copyright law under which they may not be copied, in whole or in part, without written consent of SunTech Medical.

SunTech and Tango are registered trademarks of SunTech Medical, Inc. All other trademark names are the trademarks of their respective holders.

The information in this manual is furnished for guidance only, is subject to change without notice, and should not be construed as a commitment by SunTech Medical. SunTech Medical assumes no liability for errors or inaccuracies that may appear in this manual.

© 2017 SunTech Medical. All rights reserved.



SunTech Medical, Inc.
507 Airport Blvd, #117
Morrisville, NC 27560-8200
Phone: 1-919-654-2300
1-800-421-8626
Fax: 1-919-654-2301



SunTech Medical, Ltd.
Oakfield Industrial Estate
Stanton Harcourt Road
Eynsham, Oxfordshire OX29 4TS
England
Phone: + 44 (0) 1865-884-234
Fax: + 44 (0) 1865-884-235

Other Office Location:

SunTech Medical (Shenzhen) Co., Ltd.
105 HuanGuan South Road, Suite 15 2~3/F
DaHe Community Guanlan,
LongHua District, Shenzhen
GuangDong PRC 518110
Tel: + 86-755-29588810
+ 86-755-29588986 (Sales)
+ 86-755-29588665 (Service)
Fax: + 86-755-29588829



Welcome to Tango M2!

Thank you for choosing this Tango M2 blood pressure monitor.

For over twenty-five years, SunTech Medical has been the preeminent supplier of leading edge technology and innovative products to obtain blood pressure measurements when manual readings are unreliable or simply not possible. Today, we remain focused on the continual advancement of clinical grade blood pressure technology.

Tango M2 is the latest in our line of Tango Stress Test Blood Pressure Monitors, designed specifically to work with your stress system.

What's New

- Full-color display
- Oscillometric (non-exercise) OSC MODE
 - BP readings without ECG connection
- Updated enclosure
- Power On/Off switch
- USB connection
 - Export BP measurement data
 - Easily upgrade software/firmware
- Improved cuff connector for easier patient connection

What's the Same

- Auscultatory DKA™ MODE technology
 - Reliable BP measurement during exercise
- Easy-to-read numeric display of BP and other patient information, with a waveform display of K-sounds
- Alternate graph display shows blood pressure trends
- Intuitive “push button” controls
- Simple menu-driven access to system settings
- Compatible with a broad range of stress systems to automatically receive ECG triggers and deliver readings
- Available SpO₂ option
- Available Internal ECG option
- Use with SunTech's Orbit-K blood pressure cuff or SunTech's Single Patient Use Kit (disposable cuff)

If you have used a SunTech Tango Stress Test Blood Pressure Monitor before, you can expect an effortless transition to the new Tango M2.

Table of Contents

Changes	2
Copyright Information	2
Welcome to Tango M2!	3
1. Safety Considerations.....	6
Intended Use	6
Indications for Use	6
User Responsibility	6
Precautions & Possible Adverse Reactions	6
Warnings, Cautions, and Contraindications	7
Icons, Symbols and Abbreviations.....	8
2. Setting up Tango M2	11
Unpacking the Monitor	11
Rear Panel Configuration	11
With Your Stress System.....	12
Without a Stress System.....	13
3. Getting to know Tango M2.....	14
Front Panel.....	14
Measurement View.....	15
Graph View.....	16
Main Menu	17
Applied Parts	22
4. Using Tango M2 During a Stress Test	22
Step 1. Blood Pressure Cuff Placement	23
Step 2. Confirm ECG Signal.....	24
Step 3. Take BP Readings	24
Step 4. Prepare for a New Patient	26
5. Using Tango M2 Without a Stress System.....	27
Step 1. Blood Pressure Cuff Placement	27
Step 2. Patient ECG connections	27
Step 3. Take Blood Pressure Readings	28
Step 4. Prepare for a New Patient	28
6. Using Tango M2 Options	28
Pulse Oximetry (SpO ₂).....	28
Headphone Kit	29
7. Taking Care of Tango M2	29
Cleaning	29
Preventative Maintenance.....	30
Routine Calibration	30

Software Updates	31
Product Disposal	32
Cuff Disposal	32
8. Accessories & Replacement Parts	32
9. Information Signals and Alarms	34
Information Signals	34
Alarms	36
Service Centers	38
10. Frequently Asked Questions	38
The Tango M2 displays an Information Signal. What does it mean and what do I do?	38
The Tango M2 monitor returns a result of 0/0 after blood pressure (BP) measurements. What do I need to do to get a BP reading?	38
Can I use a heart rate or blood pressure simulator to test whether the Tango M2 is working correctly with my stress system?	38
How can I adjust the brightness of the Tango M2 display?	38
How can I get MAP on my Tango M2?	39
How do I clean the Orbit-K cuff after a stress test?	39
My Tango M2 displays a message, "Please VERIFY CALIBRATION" or "Equipment Maintenance and Calibration Required." What do I do?	39
Service Centers	39
11. Technical Information	40
EMC Statement	40
Specifications, Blood Pressure Measurement	43
Standards	44
Notes on Blood Pressure Data	44
Specifications, Pulse Oximetry	44
Limited Warranty	45
Appendix A. Compatible Stress Systems	45
Appendix B. Cables for Compatible Stress Systems	47
RS-232 & ECG Interface Cables	47
Splitter Cables	47
USB Cables (Optional Cable, replaces RS-232 connection)	47
Appendix C. SpO₂ Performance Accuracy	48
Testing Summary	48
SpO ₂ Accuracy Testing	48
Low Perfusion Testing	48
Appendix D. Downloading Instructions	49
Tango M2 Excel Formatting of the Data	49

1. Safety Considerations

Intended Use

Tango M2 is a non-invasive blood pressure monitor, with the optional capability to monitor oxygen saturation (SpO₂), for use in cardiac or exercise stress testing. It measures and displays a patient's systolic and diastolic blood pressure, and with the SpO₂ option, percent oxygen saturation of arterial blood.

Use Tango M2 only with adult patients, while they undergo a cardiac or exercise stress test under the supervision of a physician.

Indications for Use

The SunTech Medical Tango M2 NIBP monitor with optional Pulse Oximeter is indicated for use in measuring and displaying blood pressure, pulse rate, and functional oxygen saturation of arterial hemoglobin (SpO₂) of adult patients in hospitals, medical facilities, and subacute environments.

Presence of atrial or ventricular fibrillation, arrhythmias, pacemakers, etc. may interfere with the normal functionality of the Tango M2 monitor.

User Responsibility

Your Tango M2 is designed to perform in conformity with the description thereof contained in this operation manual and accompanying labels and inserts, when assembled, operated, maintained and repaired in accordance with the instructions provided. It is your responsibility to:

- Check calibration of this device annually.
- Never knowingly use a defective device.
- Immediately replace parts that are broken, worn, missing, incomplete, or contaminated.
- Contact the nearest SunTech approved service center should repair or replacement become necessary. A list of approved service centers appears in the guide or on our website at www.SunTechMed.com.
- The reliability of the device depends upon conformance with the operation and service instructions, as detailed in this manual.

Further, the user of the device bears sole responsibility for any malfunction that results from improper use, faulty maintenance, improper repair, damage or alteration by anyone other than SunTech Medical or authorized service personnel.

Precautions & Possible Adverse Reactions

Use of Tango M2

Use only blood pressure (BP) cuffs supplied by SunTech Medical.

Observe the patient carefully during the procedure. Ensure pressure compatibility to all patients. If any abnormality occurs, either in the unit or the patient, suspend the operation immediately and disconnect the BP cuff, SpO₂ sensor, and electrodes (if applicable) from the patient.

Accuracy of any blood pressure reading or oxygen saturation measurement may be affected by the position of the subject, their physical condition, and use outside of the operating instructions detailed in this guide. The interpretation of blood pressure and oxygen saturation measurements should only be made by a physician.

Safety and effectiveness when used with pregnant women, children under 13 years of age and neonates have not been established.

Pulse Oximetry

Use only Nonin pulse oximeter (SpO₂) sensors supplied by SunTech Medical. Using other pulse oximeters may cause improper sensor performance.



CAUTION: Check the application site of the SpO₂ sensor frequently to confirm proper positioning of the sensor and to check the circulation and skin sensitivity of the patient.

CAUTION: Monitor patient to ensure that all cables to the patient are secured to prevent entanglement with the patient during the use of the Tango M2 system. If necessary, use the wrist straps to secure the cables to the patient's wrist.

CAUTION: Do not use a SpO₂ extension cable with the Tango M2 system. An inaccurate SpO₂ measurement may result.

Factors that may affect the accuracy of pulse oximetry:

- electro-surgical interference
- arterial catheters, blood pressure cuffs, infusion lines, etc.
- moisture in the sensor
- improperly attached sensor
- incorrect sensor type
- poor pulse quality
- venous pulsations
- anemia or low hemoglobin concentrations
- cardiovascular dyes
- sensor not at heart level
- artificial fingernails and dark colored nail polish

Possible Adverse Reactions

In the area of the BP cuff, SpO₂ sensor or electrodes, allergic exanthema (symptomatic eruption) may result, including the formation of urticaria (allergic reaction including raised edematous patches of skin or mucous membrane and intense itching) caused by the fabric material of the cuff, sensor, or electrodes.

Following the application of the BP cuff, petechia formation (a minute reddish or purplish spot containing blood that appears in the skin) or Rumpel-Leede phenomenon (multiple petechia) on the arm, which may lead to idiopathic-thrombocytopenia (spontaneous persistent decrease in the number of platelets, associated with hemorrhagic conditions) or phlebitis (inflammation of a vein) may be observed.

Warnings, Cautions, and Contraindications

Federal (U.S.) law restricts this device to sale by or on the order of a physician.

The Tango M2 NIBP monitor is defibrillator protected. The pulse oximeter is not defibrillator protected.



WARNING: No modification of this equipment is allowed.

Ensure that appropriate resuscitation equipment and personnel are available at all times during the procedure.

All alarms indicate a potential increased risk of injury if the test is continued.

DO NOT USE the monitor if it has failed its diagnostic self-test, or if it displays a greater than zero pressure with no BP cuff attached, or a value of oxygen saturation with no SpO₂ sensor attached. The values displayed by such a unit may be inaccurate.

DO NOT USE on neonates, children, and patients known to be readily susceptible to bruising.

This system is contraindicated for use in the presence of a Magnetic Resonance Imaging (MRI) device.

Do not attach the cuff to a limb being used for IV infusions or any other intravascular access, therapy or an arteriovenous (A-V) shunt. The cuff inflation can temporarily block blood flow, potentially causing harm to the patient.

 **CAUTION:** A compressed or kinked connection hose may cause continuous cuff pressure resulting in blood flow interference and potentially harmful injury to the patient.

 **WARNING:** Check periodically that operation of the AUTOMATED SPHYGMOMANOMETER does not result in prolonged impairment of the circulation of the blood of the patient.

DO NOT apply the BP cuff over a wound as this can cause further injury.

DO NOT apply the BP cuff to the arm on the side of a single mastectomy. In the case of double mastectomy use the side of the least dominate arm.

Too frequent BP measurements can cause injury to the patient due to blood flow interference.

Pressurization of the BP cuff can temporarily cause loss of function of simultaneously used monitoring equipment on the same limb.

DO NOT attach the SpO₂ sensor to the same limb as the BP cuff or any other blood flow restrictors. Loss of monitoring can occur due to the hindering of pulse measurements.

DO NOT USE in the presence of flammable anesthetics; this could cause an explosion. This monitor is not suitable for use in an oxygen enriched environment.

Avoid compression or restriction of the patient cable tubing as it will affect the BP reading.

EXPOSURE TO FLUIDS: DO NOT immerse the monitor in any fluid, place fluids on top of, or attempt to clean the unit with any liquid detergents or cleaning agents. This may cause an electrical hazard. Refer to the Cleaning section of this guide for instructions on cleaning. If any of these situations occur, please contact SunTech Medical. Protection Against Harmful Ingress of Water or Particulate Matter - Ordinary Equipment (no protection, IPX0)

DO NOT allow the SpO₂ sensor to become wet.

DO NOT use a damaged BP cuff or SpO₂ sensor. If the sensor is damaged in any way, discontinue use immediately and replace the sensor.

DO NOT REMOVE UNIT COVERS. Doing so may expose hazardous voltage and cause electrical shock. The monitor does not contain any user serviceable components.

DO NOT MAKE REPAIRS YOURSELF: No repair should be undertaken or attempted by anyone not having been service trained by SunTech Medical or having a thorough understanding of the repair and operation of automatic blood pressure equipment. (Substitution of a component different from that supplied might result in measurement error).

DO NOT position the monitor so that it is difficult to access and remove the power cord from the electrical supply. The DC power connection to the monitor of the power cord are the means of disconnection to the supply mains.



To avoid the risk of electric shock, this equipment must only be connected to a supply mains with protective earth.









DO NOT connect the monitor to equipment that does not meet EN60601-1. When the monitor is attached to a patient, the monitor's RS-232 connector & USB-B port must only be connected to equipment that meets EN60601-1.

Icons, Symbols and Abbreviations

Icons

The following icons used in this guide, on Tango M2 equipment and packaging are unique to SunTech Medical.

Icon	Definition	Standard/Source
	DKA™ MODE for auscultatory measurement of blood pressure (during exercise).	SunTech Design
	OSC MODE for oscillometric measurement of blood pressure (non-exercise).	SunTech Design

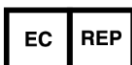



	Patient Cable connection for BP cuff (pneumatic).	SunTech Design
	Patient Cable connection for K-sound microphone.	SunTech Design
	Warranty Seal	SunTech Design
	ECG Input	SunTech Design
	BNC external ECG trigger	SunTech Design
	Headphone	SunTech Design
	Power connection configuration - positive voltage; negative shield.	SunTech Design
	No serviceable parts inside	SunTech Design
	European Authorized Representative	SunTech Design

Symbols

The following are standardized symbols that are used on the Tango M2 equipment and packaging.

The standards referenced in the Standard/Source column are:

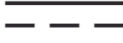
- SDO # 5-102, IEC 60417:2002 DB Graphical symbols for use on equipment
- SDO# 5-103, IEC 7000:2014 Graphical symbols for use on equipment – Registered symbols

Symbol	Definition	Standard/Source
	Warning message	ISO 7010-W001
	Caution message	ISO 7000-0434A
	SpO ₂ Sensor. Type BF Applied Part	IEC 60417 - 5333
	DC input.	IEC 60417-5031
	USB-A or USB-B	Industry
	Defibrillator protected	IEC 60417-5333



ETL Classified

Intertek



Device may contain materials which may be hazardous to human health.

WEEE Directive



Power On/Off

IEC 60417-5010



Refer to User Guide

ISO 7010-M002



No SpO₂ alarm

IEC 60417-5319



Attention, consult accompanying documents

ISO 7000-1641



Manufactured By

ISO 7000-3082



Manufacture Date

ISO 7000-2497



PSE Mark: Japanese Medical Device Approval



Indoor, Dry Location Use Only

For indoor use only

IEC 60417-5957



Product complies with the requirements of the RoHS directive, 2011/65/EU

RoHS Directive



Meets ELSA 2007, CEC efficiency level V EU (EC) No 278/2009 Phase II



Fragile

ISO 7000-0621

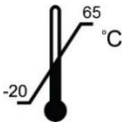

Shipping Temperature should be kept between -20° C and 65° C

ISO 7000-0632

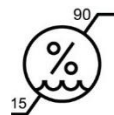

Shipping Humidity should be kept between 15% and 90%

ISO 7000-2620



CE Mark: product meets the Medical Device Directive and is CE marked to indicate conformance

EU Directive

0413



Item and shipping container should be kept dry

ISO 7000-0626



Class II isolation equipment

IEC 60417-5172



Recognized under the Component Recognition Program of UL.

Commonly Used Abbreviations

BP	Blood Pressure	NIBP	Non Invasive Blood Pressure
BPM	Beats Per Minute	OSC	Oscillometric
DKA™	Dimensional K-sound Analysis	SpO₂	Percent Oxygen Saturation of Arterial Blood (hemoglobin)
K-sounds	Korotkoff sounds	SPU	Single Patient Use
MAP	Mean Arterial Pressure	SYS	Systolic BP
DIA	Diastolic BP		

2. Setting up Tango M2

Tango M2 is designed to work directly with your stress system. When the two devices are properly connected, the stress system will automatically prompt the monitor to take blood pressure readings during the stress test study. Tango M2 will send blood pressure, SpO₂ and heart rate measurement data back to the stress system. Please reference the E-Library inside your Tango M2 monitor for proper monitor to stress system setup.

With the optional Internal ECG, Tango M2 can also be used without being connected to a stress system.

This section describes how to set up the monitor for either situation.

Unpacking the Monitor

As you unpack your Tango M2, check to make sure you have all the proper components.

Refer to the separate packing label on the inner tray stating which components you should receive based on the options you ordered with your Tango M2.

Rear Panel Configuration

All Tango M2 connections are on the back of the monitor.

- Connect your stress system to the Tango M2 using the BNC external ECG and RS-232 cables. You can use the USB cable instead of the RS-232 cable if your Tango M2 came with this option. Please view the Interface Notes in the E-Library inside your Tango M2 to see the correct set-up between these two systems.

- Patient Cable & ECG Cable “Defibrillation-proof Type BF Applied Part” and SpO₂ is a “Type BF Applied Part.”
- If your Tango M2 has the Internal ECG option, then there will be an ECG connector. If not, the ECG port will be plugged.

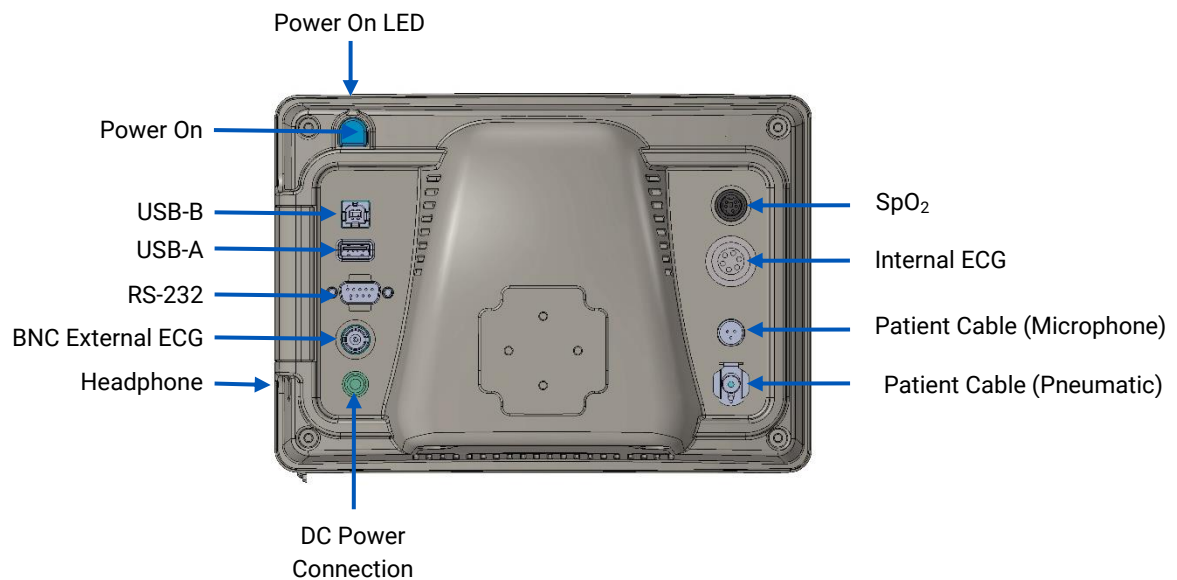

With Your Stress System

Tango M2 can be connected to a broad range of stress systems. Appendix A. contains a list of compatible stress systems.

Connection of Tango M2 to a stress system should be done by a biomedical technician or other person familiar with blood pressure and ECG stress system equipment. Your SunTech Medical sales representative may be able to assist you with this installation.

Interface Notes

Interface Notes are available from SunTech Medical for most Tango M2 compatible stress systems. Interface Notes provide detailed instructions, with supporting illustrations and frequently asked questions about proper setup and use.

Visit the SunTech Medical website at www.SunTechMed.com to download Interface Notes for any compatible stress system. Go to the Support tab, then choose: [Customer Technical Support > Download Library > Stress BP Monitors > Tango M2 > Interface Notes](#) for a list of available Interface Notes.

You may also reference the E-Library within your Tango M2 monitor for help with setup between the two systems: [Main Menu > Monitor Setup > E-Library > Interface Notes](#) for a list of available Interface Notes.

NOTE: Refer to the Interface Notes for your stress system before proceeding with installation!

If your stress system is not listed in the library of Interface Notes, contact SunTech Customer Service:

Email CustomerService@SunTechMed.com

Phone US: 800.421.8626 / 919.654.2300

Europe, Mediterranean & East Africa: 44 (0) 1865.884.234

Asia & Pacific: 852.2251.1949

Attach Connections to the Monitor

Connect the Power Supply to a Power Cable, and plug into an available AC power outlet. Connect the Power Supply to the DC input connector on the back of the monitor.

Connect the Patient Cable to the Microphone and Pneumatic connectors on the back of the monitor.

Follow the instructions provided in the Interface Notes to connect Tango M2 to the stress system.

Use the ON/OFF button on the back of the Tango M2 monitor to turn it on.

NOTE: The blue LED on the top of Tango M2 will be lit whenever the monitor is powered on.

Within 30 seconds, the SunTech Tango M2 logo will appear briefly, then be replaced by the Main Display screen (Measurement View is the default).

Select Monitor and Stress System settings

Follow the instructions provided in the Interface Notes to select settings for both the Tango M2 monitor and the stress system.

If you experience difficulty communicating with the stress system, contact SunTech Customer Service:

Email CustomerService@SunTechMed.com

Phone US: 800.421.8626 / 919.654.2300

Europe, Mediterranean & East Africa: 44 (0) 1865.884.234

Asia & Pacific: 852.2251.1949

When the monitor and stress system settings have been selected, the installation is complete.

Confirm Connections

Test the combined system by taking a blood pressure measurement to confirm that Tango M2 is working properly with the stress system. Follow the instructions in the Using Tango M2 during a Stress Test section of this guide (PG #29).

Without a Stress System

Tango M2 can be used without attaching it to a stress system.

NOTE: If your Tango M2 has Internal ECG option, it can take both auscultatory and oscillometric blood pressure measurements. If your Tango M2 does not have the Internal ECG option, it can only take oscillometric blood pressure measurements.

Setup should be done by a trained biomedical technician or an authorized SunTech distributor that is familiar with automated blood pressure and ECG equipment.

Connect the Power Supply to a Power Cable, and plug into an available AC power outlet. Connect the Power Supply to the DC input connector on the back of the monitor.

Connect the Patient Cable to the Microphone and Pneumatic connectors on the back of the monitor. Connect the ECG Cable to the Internal ECG connector on the back of the monitor.

Use the ON/OFF button on the back of the Tango M2 monitor to turn it on.

NOTE: The blue LED on the top of Tango M2 will be lit whenever the monitor is powered on.

Within 30 seconds, the SunTech Tango M2 logo will appear briefly, then be replaced by the Main Display screen (Measurement View is the default).

If using Tango M2 with Internal ECG, SunTech recommends setting a CUSTOM ECG trigger, by selecting: [Main Menu > Monitor Setup > Stress System > Custom > Protocol: SUNTECH > ECG Trigger: INTERNAL](#)

Tango M2 is now ready to use as a blood pressure monitor without being connected to a stress system.

3. Getting to know Tango M2

Tango M2 offers two different screens that can be selected as the Main Display for viewing patient readings: Measurement View (default setting) and Graph View.

Using the Main Menu you can change the view of your monitor, adjust the brightness of the monitor, change the measurement settings, set user defined alarms and view your measurement data. Each of these screen displays and functions are described later in this guide.

Front Panel

The ON/OFF button is blue and located on the top back right corner of the monitor. Use the six buttons on the front panel to operate the monitor. The blue LED on the top of Tango M2 will be lit whenever the monitor is powered on.

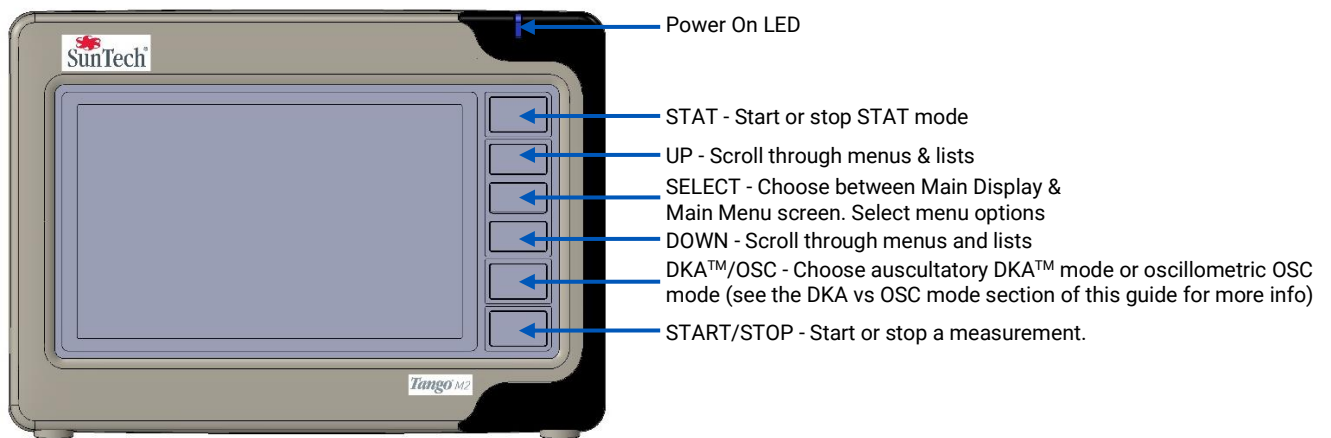

Measurement View

The Measurement View screen displays the current or most recent patient measurements as numeric readings.

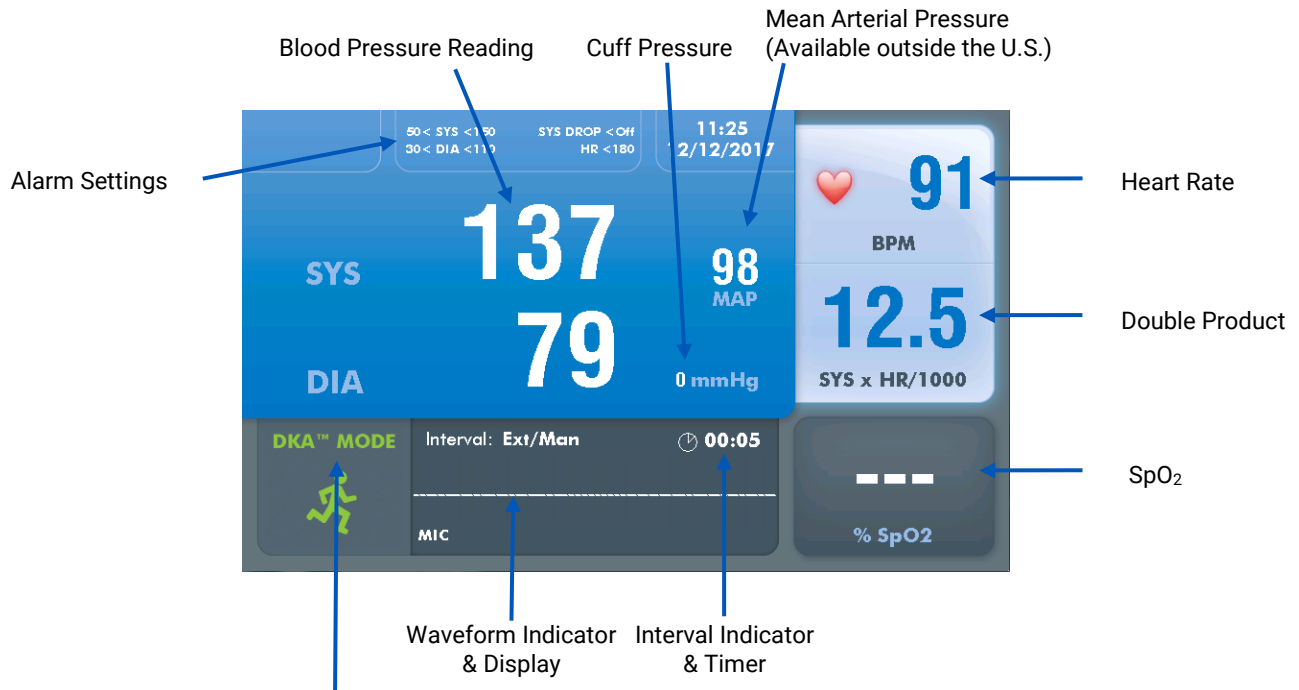

A green “running man” icon indicates that the monitor is set to take blood pressure readings in auscultatory (exercise) DKA™ MODE.



An orange “running man” icon with a slashed circle indicates that the monitor is set to take blood pressure readings in oscillometric (non-exercise) OSC MODE. The patient must remain still.

See the DKA™ MODE vs. OSC MODE section of this guide for more information.

Notes on Measurement View:

Full BP vs. Systolic-only Readings

- If the SYS field shows a reading but the DIA field is blank, the monitor has been set to read systolic-only blood pressure readings.

Mean Arterial Pressure

- The MAP field will be blank and the MAP icon will not appear when Mean Arterial Pressure is turned off. (This is a factory setting. MAP is not available in the US.)

Heart Rate

- While a BP measurement is being taken in DKA™ MODE, a blinking heart icon indicates the systolic/diastolic range of the reading (i.e., K-sounds are detected).
- In OSC MODE, HR is not displayed until the end of the BP measurement.

SpO₂

- The SpO₂ field will display dashes if the SpO₂ sensor is attached to the monitor but is not connected to a patient.
- The SpO₂ field is greyed out when SpO₂ is not connected and displayed in blue if SpO₂ is connected.
- The SpO₂ field will be blank if no SpO₂ sensor is attached to the monitor.

Interval / Timer

- Timer displays in minutes & seconds.
- When the Interval is displayed as "EXT/MAN", the monitor will take BP readings only when prompted, either by a stress system or by a manual button press. The timer will count up from the end of the last BP reading. The clock icon is inactive.
- When an Interval time is displayed, the monitor will take BP readings at timed intervals (also when prompted by a stress system or by a manual button press). The timer will count up from the start of the last BP reading. The clock icon fills in to show when the next reading will start.
- When in STAT mode, the red STAT icon is displayed. The timer will count up from the end of the last BP reading.

Waveform Display

- The waveform will normally show the K-sounds picked up by the microphone in the cuff. The waveform can be set to display the ECG channel, but it will revert to displaying the K-sounds after 60 seconds.

Graph View

The Graph View screen displays a graphic summary of the most recent blood pressure measurements, in addition to numeric display of the other readings available in the Measurement View.

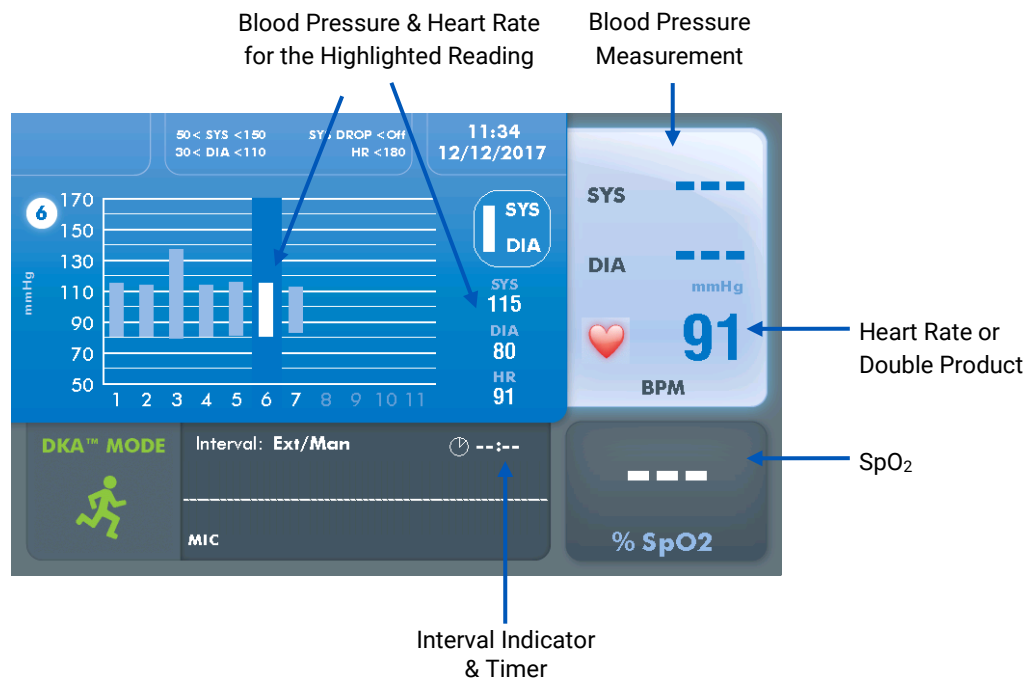

An orange "running man" icon with a slashed circle indicates that the monitor is set to take blood pressure readings in oscillometric (non-exercise) OSC MODE. The patient must remain still.



A green "running man" icon indicates that the monitor is set to take blood pressure readings in auscultatory (exercise) DKA™ MODE.

See the DKA™ MODE vs. OSC MODE section of this guide for more information.

Notes on Graph View:

BP Trend Graph

- The graph will display up to 15 readings at a time but will hold 50 BP readings. Use the UP and DOWN buttons to scroll back and forth to see the 50 most recent readings.

- Full BP readings are shown with a bar; systolic-only readings are shown as a dot. Measurements with errors or information Signals will not be shown on the graph.
- The sequence number, BP, and heart rate values for the highlighted reading are shown at the top of the screen.

BP Reading / Cuff Pressure

- The most recent BP reading will appear at the top right of the screen.
- While a measurement is being taken, the cuff pressure will appear in the top right of the screen.

Heart Rate / Double Product

- Heart Rate is displayed as a default setting; monitor can be set to display Double Product instead.

SpO₂, External/Manual vs. Interval, and Waveform Display

- Refer to Measurement View.

To use Graph View as the Main Display screen, press SELECT to reach the Main Menu use the up and down arrow keys to navigate to: **View > Main Display > Graph** press the SELECT key to confirm your selection. Then press START/STOP to return to the Main Display (which is now set to Graph View).

Main Menu

Press the SELECT button to view the Main Menu screen.

Use the Main Menu to set up the monitor, adjust measurement and display settings, set alarms, view and export measurement data, and view reference information.

MAIN MENU	
Monitor Setup	Stress System Custom
Measurement Setup	└ Protocol SunTech
View	└ ECG Trigger Digital Rising
Alarms	Language: English
Measurement Table	Date and Time
End Test	Brightness: 70
Exit	Sleep Mode After: 30
	Reset Warning Prompt
	E-Library
	System Info

- Use the UP and DOWN buttons to scroll through screen menus or lists of options.
- Use the SELECT button to confirm highlighted submenu or item in a list.

In any menu, scroll to EXIT and press SELECT to return to previous menu.

Press START/STOP to return to the Main Display from any level in the Main Menu.

The following charts list the Menu Options, available choices and default settings.

Monitor Setup

Menu Option		Options (Default)
Stress System	Select a preconfigured setting for your stress system, or choose custom settings:	Choose from a list of available settings, or CUSTOM
	If "CUSTOM", select protocol and ECG trigger. Select protocol:	Choose from a list of available protocols, or SunTech
	Select trigger:	Analog Digital falling Digital rising (default) Internal
Language*	Select language for monitor display:	English (default) Francais Deutsch Italiano Español
Date & Time	Select format and set current date and time.	
	Choose Date format, then set Date:	MM/DD/YYYY DD.MM.YYYY DD MMM YYYY
	Choose Time format, then set Time:	12 hr: Format is "HH:MM AM/PM" (HH = 01-12; MM = 00-59) 24 hr: Format is "HH:MM" (HH = 00-23; MM = 00-59)
Brightness	Set brightness level from 0 to 100. 0 is darkest; 100 is lightest.	70
Sleep Mode After	Select time delay for monitor to enter sleep mode after last activity:	Never (default) 10 min 30 mins
Reset Warning Prompts	Use to reset warning prompt for transition from DKA MODE to OSC MODE.	Yes / No
E-Library	Select Tango M2 information to display on screen:	1. Interface Notes 2. Tutorials 3. Information Signals
System Info	Displays firmware version and internal board serial number. Select "Software Update" to begin a software update Select "Exit" to return to Monitor Setup menu.	Software Update / Exit
Exit	Select to return to Main Menu.	

*Once the language selection has been made the Tango M2 must cycle power to have this language take effect.

Measurement Setup

Menu Option		Options (Default)
Measurement Mode	Select type of BP reading to be taken: BP – both systolic and diastolic / SYS – only systolic* (not available in OSC MODE)	BP / SYS
Interval	Select external/manual triggering, or a time interval for automatic readings: Time intervals are in min:sec.	EXT/MAN (default) 1:00 1:30 2:00 2:30 3:00 4:00 5:00 10:00 20:00
Initial Inflate	Set initial inflate pressure for cuff from 120-280 mmHg, in increments of 10 mmHg.	180 mmHg
Max Inflate	Set maximum inflate pressure for cuff from 120-280 mmHg, in increments of 10 mmHg.	280 mmHg
Deflate Rate	Select deflate rate for cuff. AUTO = approx. 4 mmHg/heart beat If heart rate is over 100 BPM, the monitor may deflate at a higher rate than selected.	AUTO (default) 3 mmHg/sec 4 mmHg/sec 5 mmHg/sec 6 mmHg/sec 7 mmHg/sec 8 mmHg/sec
Beeper	Select whether monitor will beep during a BP reading:	Start Finish (default) Both Never
Stat Mode Key	Select type of BP reading to be taken during STAT mode: BP – both systolic and diastolic / SYS – only systolic (not available in OSC MODE)	BP (default) / SYS
Exit	Select to return to Main Menu.	



* **WARNING:** SYS measurement mode is for research purposes only. Readings taken during SYS mode should not be used to make diagnostic decisions.

View

Menu Option		Options (Default)
Main Display	Select view to be the Main Display:	Measurement (default) / Graph
Waveform Display	Select signal displayed in Waveform Display field: If "ECG" is selected, the signal will be displayed for 60 seconds, then Waveform Display will return to K-sound.	K-sound / ECG
Graph Display	Select value displayed on Graph View below BP reading:	HR (default) / DP
BP Clear After	Select time delay before a BP measurement is cleared from display: # = minutes	Never 1 2 3 5 [minutes (default)] 10
BP Shrink After	Select time delay before a BP measurement is displayed in a smaller font: # = minutes	Never 1 [minutes (default)] 2 3 5 10
New Patient	Select monitor response when ECG signal is dropped for 1 minute: If "Auto", monitor will automatically reset when ECG signal is lost for 1 minute. If "Prompt", monitor will display "New Patient?" prompt, and require confirmation before resetting.	Auto / Prompt (default)
BP Pressure Units	Select unit of measure for BP readings:	mmHg (default) / kPa
Exit	Select to return to Main Menu.	

Alarms

Menu Option		Options (Default)
SYS High	Select high systolic pressure threshold to activate alarm. Options are: 1) "OFF", 2) for Systolic Pressure in DKA from 50-270mmHg or 3) for Systolic Pressure in OSC from 50-260mmHg, in increments of 10mmHg to set alarm.	OFF (default)
SYS Low	Select low systolic pressure threshold to activate alarm. Options are: "OFF" or a systolic pressure from 40-110 mmHg, in increments of 10 mmHg, to set alarm.	OFF (default)

Menu Option		Options (Default)
SYS Drop	Select drop in systolic pressure from previous reading to activate alarm. Options are: "OFF" or a drop of from 10-100 mmHg, in increments of 5 mmHg, to set alarm. This alarm resets when a new patient is started.	OFF (default)
DIA High	Select high diastolic pressure threshold to activate alarm. Options are: "OFF" or a diastolic pressure from 20-160 mmHg, in increments of 10 mmHg, to set alarm.	OFF (default)
DIA Low	Select low diastolic pressure threshold to activate alarm. Options are: "OFF" or a diastolic pressure from 20-90 mmHg, in increments of 10 mmHg, to set alarm.	OFF (default)
HR High	Select heart rate threshold to activate alarm. Options are: "OFF" or heart rate from 40-200 beats per minute, in increments of 10 bpm, to set alarm.	OFF (default)
Exit	Select to return to Main Menu.	

Measurement Table

Menu Option		Options (Default)
	Data for the 6 most recent measurements will appear in a table: # (see note below) Date Time Systolic & Diastolic BP Readings Heart Rate Mean Arterial Pressure Information Signals (if any) The Measurement Table holds up to 300 measurements. Use ARROW buttons to scroll through data. The "#" field is a sequential numbering of measurements, (it will record "NP" for the first BP reading each time a New Patient is identified).	
View Full Table	Select to view table of measurement data in full screen display. Press SELECT to return to Main Menu.	n/a
Download Data	Select to download data to a USB-A flash drive.	n/a
Exit	Select to return to Main Menu. A "Clear measurement table?" prompt will appear. If "Yes", data will be erased from table. If "No", data will be saved.	Yes No

The Measurement Table holds up to 300 individual BP measurements. Once 300 BP readings are collected in the table, the oldest measurements will be overwritten by new measurements.

Please see Appendix D for instructions on how to download the data from the measurement table to your flashdrive and how to format the data in Excel.

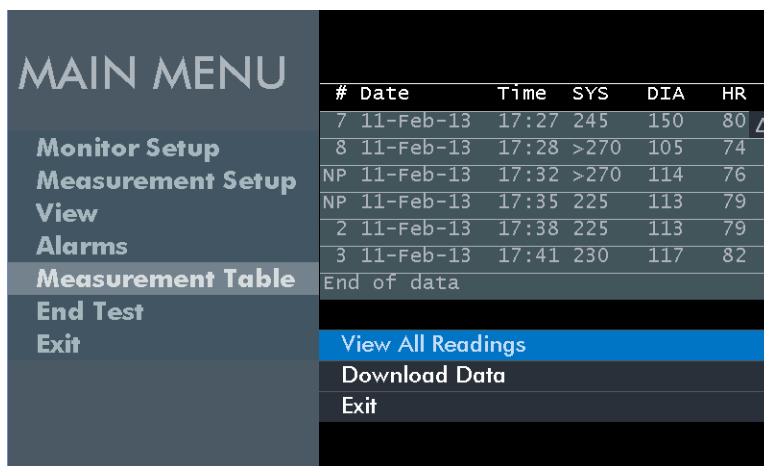

End Test

Use “End Test” to clear display readings and prepare the monitor for a new patient.

Menu Option	Options (Default)
<p>An “End Test?” prompt will appear.</p> <p>If “Yes”, monitor will clear readings from display, prepare monitor for a new study, and return to the Main Menu.</p> <p>If “No”, monitor will keep readings and settings, and return to the Main Menu.</p>	Yes (default) / No

Applied Parts

The SpO₂ Sensor and BP Cuffs are Type BF Applied Parts. The ECG Leads and the BP Cuffs are also defibrillation-proof Applied Parts.

4. Using Tango M2 During a Stress Test

Follow these steps to use Tango M2 when connected to a stress system:

1. Measure the patient’s arm to ensure proper cuff sizing.
2. Place a blood pressure cuff on the patient’s arm
3. Make sure the monitor is receiving an ECG signal
4. Take blood pressure readings
5. End test / prepare system for the next patient

You should be familiar with taking blood pressure measurements and conducting ECG stress tests before using Tango M2 with your stress system.

Step 1. Blood Pressure Cuff Placement

Use either a SunTech Orbit-K™ blood pressure cuff or a SunTech Single Patient Use kit (containing a disposable blood pressure cuff and microphone pad). This section gives directions for proper size selection and placement of either style of cuff.

NOTE: It is important that the cuff is properly fitted to the patient's arm, and that the microphone is placed over the brachial artery (between the bicep and tricep)! Improper cuff sizing and a misplaced microphone can lead to missed or poor readings and accuracy.

Orbit-K™ Cuff

The Orbit-K cuff is available in four sizes. (For sizes please see PG #48) Check that the cuff is the correct size:

1. Fold the grey sleeve inside the blue cuff (away from the Velcro strip).
2. Wrap the cuff around the patient's upper arm.
3. Make sure the INDEX (the end of the cuff) falls within the RANGE (printed inside the cuff).
4. If the INDEX falls outside the RANGE, select a new cuff size.

This section gives directions for proper size selection and placement of either style of cuff.

- a. Locate the brachial artery, between the bicep and the tricep of the upper arm. The left arm is preferred.
- b. Slide the cuff sleeve up the patient's arm, with the "ARTERY" marker pointing down the arm.
- c. There is a microphone located under the "ARTERY" marker. Make sure the microphone is placed on the inner portion of the arm, directly over the brachial artery between the bicep & tricep. There should be about 3 to 5 cm (two finger widths) between the edge of the cuff and the elbow.
- d. Insert the 3-pin microphone connector from the cuff into the corresponding connector on the Patient Cable. The connector can be inserted in any orientation.
- e. Connect the tube from the cuff into the corresponding connector on the Patient Cable and twist.
- f. Wrap the cuff around the arm and secure. Use the wrist straps to secure the cables to the patient's wrist.

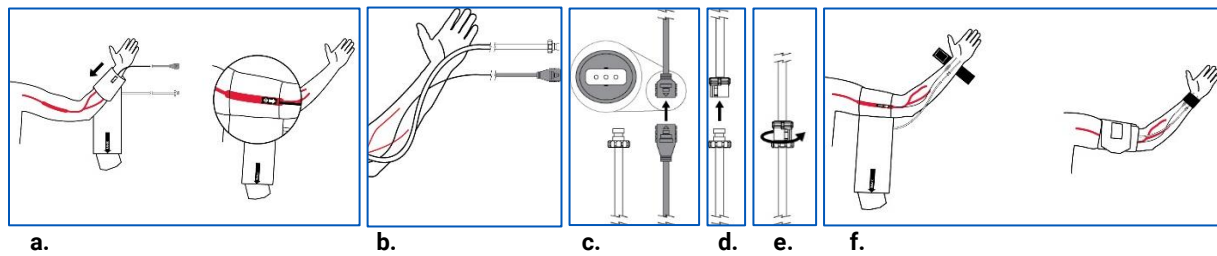

NOTE: You may find it easier to connect the Patient Cable to the cuff before applying the cuff to the patient.

Disposable Cuff

The SunTech Single Patient Use (SPU) kit is available in five sizes. Each SPU kit contains one disposable cuff and one disposable microphone pad. Use the microphone from the Orbit-K cuff included with the monitor, or you can order the 12" K-Sound microphone, PN 98-0235-01 designed for use with the SPU Kits from SunTech Medical.

To remove the microphone from the Orbit-K cuff, open the Velcro strip and gently pull the microphone out of the sleeve. Clean the microphone before using with a mild medical grade disinfectant (see section 7 for cleaning).

Check that the cuff is the correct size:

1. Wrap the cuff around the patient's upper arm.
2. Make sure the INDEX (the end of the cuff) falls within the RANGE (printed inside the cuff).
3. If the INDEX falls outside the RANGE, select a new cuff size.



WARNING: Using an incorrect cuff size could result in erroneous and misleading BP measurements!

NOTE: Adhesive pads should be used or discarded by the use by date given by the manufacturer.

- Locate the brachial artery, between the bicep and the tricep. Place the microphone onto the microphone pad. Peel the protective film from the microphone pad.
- Place the microphone on the patient's arm making sure that the microphone is placed on the medial part of the arm, directly over the brachial artery between the bicep and tricep. There should be about 3 to 5 cm (two finger widths) between the microphone pad and the elbow.
- Wrap the cuff around the arm and secure.
- Insert the 3-pin microphone connector from the cuff into the corresponding connector on the Patient Cable. The connectors can be inserted in any orientation.
- Connect the tube from the cuff into the corresponding connector on the Patient Cable and twist.
- Use the wrist straps to secure the cables to the patient's wrist.

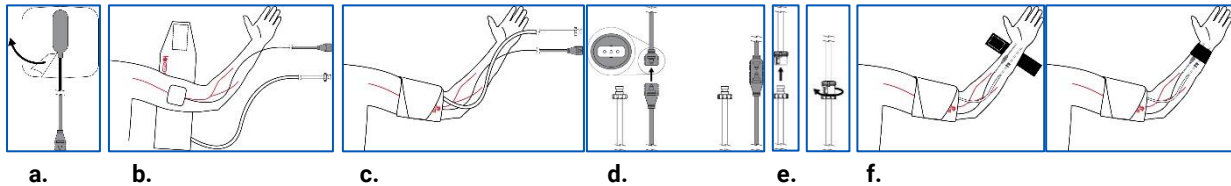

NOTE: You may find it easier to connect the Patient Cable to the cuff before applying the cuff to the patient.

Step 2. Confirm ECG Signal

Tango M2 requires an ECG signal to take blood pressure measurements during the stress test. The monitor receives this ECG signal automatically from the stress system once the patient ECG connections are in place.

NOTE: Tango M2 can be used in OSC MODE to take blood pressure readings without an ECG signal before exercise begins. The patient must remain still while these readings are being taken! Refer to the DKA MODE vs. OSC Mode section of this guide for more information.

If patient ECG connections are not already in place, follow the instructions provided with your stress system for placement of ECG electrodes and connection of leadwires.

Make sure that a stable heart rate is displayed on the Tango M2 monitor.

Step 3. Take BP Readings

NOTE: Tango M2 must be set to DKA Mode to take BP measurements while the patient is exercising.

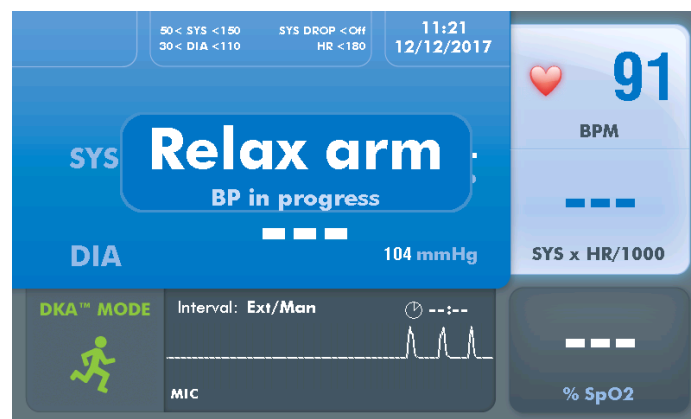

Once the stress test begins, the stress system will prompt the monitor to take blood pressure readings. The cuff will automatically inflate for each measurement. The message “RELAX ARM BP in progress” will be displayed until the measurement is complete, then the reading will be displayed. You can also press the START/STOP button to manually prompt the monitor to take blood pressure readings. This same button can be used to abort a reading if necessary.

Display of Readings

Blood Pressure and Double Product readings display in a large font as soon as each measurement is complete. After one minute, these readings shrink to a smaller font. After five minutes these readings reset to dashed lines. (These times are default settings that can be reset using the Main Menu > View menu.)

Readings at Timed Intervals

If Controlled by the Stress System

When the Tango M2 is connected to a stress system, the stress system will control the BP intervals. The Tango M2 will follow a predetermined BP interval protocol driven by the stress system. In this instance, the timed intervals do not need to be programmed into the Tango M2.

Not Controlled by the Stress System

Tango M2 can be set to take additional blood pressure readings at timed intervals from one to 20 minutes, by selecting the [Main Menu > Measurement Setup > Interval](#) option.

The selected interval time will appear on the display. The timer will count up from the start of the last measurement. When the timer reaches the set time interval, a new blood pressure reading will be taken.

While set to a timed interval, the monitor will continue to respond to external prompts from the stress system and to manual prompts using the START/STOP button. Each external prompt or manual prompt will restart the interval timer.

Stopping a Reading

Press the START/STOP button to stop a blood pressure measurement in process. The cuff will deflate, the monitor will beep once (unless the beeper is turned off), and the message: "ABORT" will appear briefly on the display. The blood pressure reading will display dashed lines until the next measurement is taken.

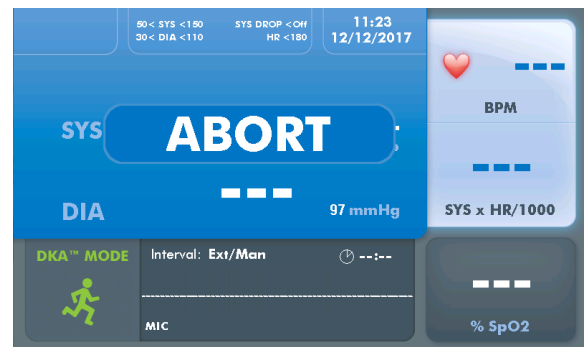

STAT Mode

Press the STAT button to take repeated blood pressure measurements for time sensitive or emergency situations. The monitor will take repeated measurements for 10 minutes. The cuff will automatically inflate for each measurement. A red STAT icon will appear on the display and the blood pressure readings will blink as long as the monitor is in STAT mode. Cancel STAT mode by pressing the START/STOP button or the STAT button again. STAT mode will also be canceled if the monitor receives a STOP message from the stress system. All monitor buttons other than STAT and START/STOP are inactive during STAT mode.

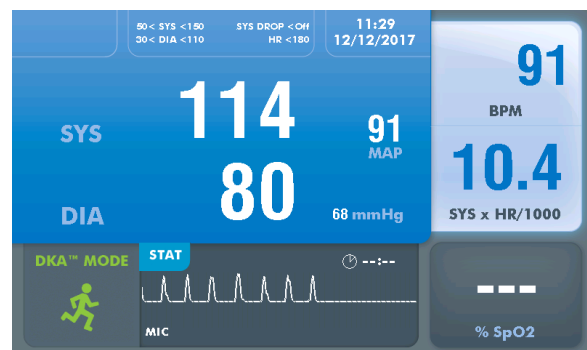

The default setting for STAT mode is to take a full BP that includes both systolic and diastolic readings taken every 10 seconds from the end of each measurement. The monitor can be reset to take systolic-only readings every 2 seconds, by selecting the [Main Menu > Measurement Setup > Stat Mode Key](#) option.

Full systolic and diastolic measurements can take as little as 30 seconds to appear on the display.

Systolic-only measurements can take as little as 15 seconds to appear.

After 10 minutes, or when STAT mode is canceled, the monitor will return to the Main Display.

DKA™ MODE vs. OSC MODE

Tango M2's default DKA™ MODE uses an auscultatory technique for measuring blood pressure.

SunTech Medical's proprietary Dimensional K-sound Analysis (DKA™) algorithm uses the ECG signal and K-sound pattern recognition to filter out noise, making DKA™ MODE highly tolerant to patient movement. DKA™ MODE requires that the monitor receive an ECG signal from the patient.

An alternate oscillometric OSC MODE is available to take blood pressure readings without requiring an ECG signal.

NOTE: The patient must remain still while oscillometric measurements are being taken!

Press the DKA/OSC button to select oscillometric OSC MODE. The OSC MODE icon will appear with the message "NON-EXERCISE MODE / Patient must remain still". There are some differences in monitor behavior while in OSC MODE:

BP Readings

- BP measurements are displayed as a full BP (systolic and diastolic) reading. (Systolic-only setting is not available in OSC MODE.)

Heart Rate

- Heart Rate is not displayed until the end of each BP measurement.
- The HEART icon does not blink.

Main Menu Settings

- Waveform Display is inactive.
- Measurement Mode and Stat Mode can only be set to full BP.
- Fixed regulatory standard settings are used for Max Inflate and Deflate Rate.

Monitor Sleep Mode

The monitor will enter a sleep mode if there is no communication from the stress system and no activity on the monitor for 30 minutes. (This is a default that can be reset by selecting the [Main Menu > Monitor Setup > Sleep Mode After](#) option.) While in Sleep Mode, the display will appear blank but the blue LED on the top of the monitor will stay lit.

Communication from the stress system or a button push on the monitor will wake the monitor.

Step 4. Prepare for a New Patient

When the stress test is finished, remove the cuff from the patient's arm. Disconnect the cuff from the Patient Cable.

NOTE: If using the Orbit-K cuff, clean the cuff sleeve and the inside of the cuff with a mild medical grade disinfectant. If using the SPU kit, discard the used disposable cuff and microphone pad. Clean the microphone with a hospital-grade mild disinfectant and retain for future use (see section 7).

The monitor will automatically reset for a new patient when the ECG signal has been dropped for over a minute (i.e., when the ECG leads are removed from the patient). All patient information displays will be cleared.

Instead of automatically resetting, Tango M2 can be set to display a "New Patient?" prompt when the ECG signal drops, by selecting the [Main Menu > View > New Patient](#) option.

You can also manually reset the monitor for a new patient by selecting [Main Menu > End Test](#).

Tips for Conducting an Exercise Stress Test

Here are some helpful suggestions for taking blood pressure measurements during a stress test.

Practice measurements

Take a few measurements before starting exercise.

- Take one or two blood pressure measurements with the patient seated or standing still in DKA mode. This creates a baseline BP.
- As the measurement is being taken, watch the cuff pressure and K-sounds display. You should see K-sounds just as you would hear them if taking a manual blood pressure measurement with a stethoscope.

Once you get a stable baseline blood pressure reading, proceed with the stress test. If you are having trouble, consult the Information Signals & Alarms section of this guide for more suggestions.

Make sure your patient's arm is relaxed

Have your patient limit the movement of the cuff arm while their blood pressure is being measured. A gentle swinging is acceptable; bending at the elbow is not.

Avoid flexing the muscles of the cuff arm.

If your patient is holding onto the treadmill bar for support, see if they can rest the hand of the cuff arm on the treadmill bar, with their palm facing up. Another option is to have the patient drop the arm with the cuff to their side during the reading. If the patient needs to hold the bar for support, advise them to grip the bar as lightly as possible. A tight grip on the bar can increase the noise that the k-sound microphone hears due to the muscle flexing in the patient's arm.

To monitor blood pressure more closely

If your patient's condition becomes unstable and you need to monitor them more closely, you can set the monitor to STAT mode by pressing the STAT button.

Cancel STAT mode by pressing the START/STOP button or the STAT button again.

Watch for Information Signals and Alarms

There is a full description of Tango M2 Information Signals and Alarms in the Information Signals & Alarms section of this guide.

5. Using Tango M2 Without a Stress System

Follow these steps to use Tango M2 with an Internal ECG option when it is not connected to a stress system:

1. Measure patient's arm to ensure proper cuff sizing.
2. Place a blood pressure cuff on the patient's arm
3. Set up patient ECG connections
4. Take blood pressure readings
5. End study / prepare system for next patient

You should be familiar with taking blood pressure measurements before using Tango M2.

Step 1. Blood Pressure Cuff Placement

Use either a SunTech Orbit-K™ blood pressure cuff, or SunTech Single Patient Use kit (containing a disposable blood pressure cuff and microphone pad).

NOTE: It is important that the cuff is properly fitted to the patient's arm, and that the microphone is placed over the brachial artery inbetween the bicep and tricep on the inner portion of the upper arm.

Refer to Step 1. Blood Pressure Cuff Placement in the previous section of this guide for proper size selection and placement of either style of cuff.

Step 2. Patient ECG connections

Prepare and connect 3 ECG electrode sites: RL, V2, and V6.

- Place each electrode over a bony area, not over a large muscle mass.
- Prepare the skin at each electrode by shaving any excess body hair. Clean each site thoroughly with alcohol.
- For best results, skin impedance should be less than 5 kohms as measured by a skin impedance meter.

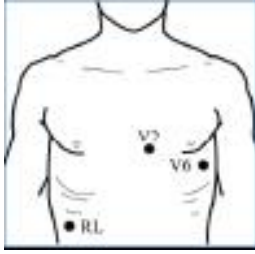

Connect the ECG cable to the electrodes as follows:

- Green lead to RL
- Yellow lead to V2
- Violet lead to V6

Make sure that a stable heart rate is displayed on the Tango M2 monitor.

Step 3. Take Blood Pressure Readings

Press the START/STOP button to manually prompt the monitor to take blood pressure readings. Take Blood Pressure Readings in the previous section of this guide for information about other Tango M2 functions:

- Readings at Timed Intervals
- Stopping a Reading
- STAT Mode
- DKA™ MODE vs. OSC MODE
- Monitor Sleep Mode

Step 4. Prepare for a New Patient

When you are finished taking blood pressure measurements, remove the cuff and ECG electrodes from the patient. Disconnect the cuff from the Patient Cable.

NOTE: If using the Orbit-K cuff, clean the cuff sleeve and the inside of the cuff with a mild medical grade disinfectant. If using the SPU kit, discard the used disposable cuff and microphone pad. Clean the microphone with a hospital-grade mild disinfectant and retain for future use.

Refer to Step 4. Prepare for a New Patient in the previous section of this guide for information about resetting the monitor.

6. Using Tango M2 Options

Pulse Oximetry (SpO₂)

The optional SpO₂ sensor allows you to measure the oxygen saturation of arterial blood and display this reading on the Tango M2. If your Tango M2 did not come with an SpO₂ sensor (PN #98-0233-01) you can order this option from your local SunTech Medical representative (see page #69).

Plug the SpO₂ sensor cable into the SpO₂ connector on the back of the monitor.

NOTE: Do not use the SpO₂ sensor on the same arm as the blood pressure cuff. The SpO₂ reading may be compromised, unattainable, or inaccurate.

NOTE: If the sensor is not positioned properly, light may pass the tissue and result in pulse oximetry inaccuracies. Proper sensor placement is critical for good performance.

- Insert a finger (preferably the index, middle or ring finger) into the SpO₂ Sensor until the end of the finger reaches the finger stop. Do not use the thumb.
- Keep the fingernail facing the sensor top. Make sure that long fingernails are not interfering with proper finger position.

NOTE: Some nail polish colors (particularly dark shades) or artificial fingernails may reduce light transmission and affect pulse oximetry accuracy. Remove any nail polish or artificial fingernails before using the SpO₂ sensor.



CAUTION: *Inspect the sensor application site to ensure correct sensor alignment and skin integrity. Patient sensitivity to sensor may vary due to medical status or skin condition. Check frequently. If allergic reaction develops, stop use immediately and contact SunTech Medical.*

- c. Use medical tape around the base of the fingers to secure the sensor cable during the stress test. Make sure that the tape securing the cable does not restrict the blood flow.

NOTE: *Patient sensitivity to tape may vary due to skin conditions. Discontinue use of adhesive tape strips if the patient exhibits an allergic reaction to the adhesive materials.*

An SpO₂ reading will be displayed after a few seconds. The SpO₂ measurement data is updated every 1/3rd of a second, and the displayed value is updated every 1 second. A 4-beat SpO₂ average is used to display a reading. Any temporary loss of signal will affect the accuracy of this reading due to this averaging.

There is no alarm associated with SpO₂. An SpO₂ reading will not be displayed due to any of the following issues: weak or loss of signal, or an open circuit due to a damaged cable. The Tango M2 will shut down if the cable's voltage is shorted to ground until the fault is removed. In the case of a damaged cable remove the SpO₂ cable from the Tango M2 and resume normal use of the Tango M2. Call SunTech Customer Service for assistance with the damaged SpO₂ cable.

Headphone Kit

Headphones allow you to listen to the K-sounds that are picked up by the microphone in the cuff. These sounds are similar to what you hear when taking a manual BP.

Plug the headphone jack into the port on the right side of the monitor.

NOTE: *Headphones should only be used as an evaluation/reference tool, not as a diagnostic tool.*

7. Taking Care of Tango M2

Cleaning

Monitor



CAUTION: *Tango M2 is not sterilizable. Do not immerse the monitor in any fluid or attempt to clean with any liquid detergents, cleaning agents, or solvents.*

Dampen a soft cloth with mild medical grade disinfectant and wipe the monitor to remove surface dust and dirt.

Orbit-K Cuff

NOTE: *Orbit-K cuff and patient cable should be cleaned at the conclusion of each stress test.*

Periodically, remove the bladder and microphone for cleaning. Dampen a soft cloth with a mild medical grade disinfectant and wipe the bladder and microphone, let them air dry. Clean the cuff sleeve and the inside of the cuff with a mild medical grade disinfectant. It is recommended that after heavy use the fabric shell of the Orbit-K cuff be machine-washed in cold water with a mild disinfectant. Line dry this cuff only - machine drying can cause damage to the fabric shell of the Orbit-K cuff.

The bladder needs to be inserted back into the cuff sleeve so the pneumatic hose portion of the bladder is outside the sleeve. Please note that the pneumatic hose connection should face downward when using the Orbit-K cuff on either the right or the left arm.

 CAUTION: Do not machine wash bladder or microphone.

Patient Cable & ECG Cable

 CAUTION: Do not immerse cable and connectors in fluid.

To clean, use a soft cloth to apply a mild soap and water mixture. Remove any residue and wipe dry.

To disinfect, use a hospital-approved disinfectant such as: 1:10 chlorine bleach, Lysol® disinfectant, 2% glutaraldehyde solution, or Wescodyne®.

NOTE: To control infection, follow your facility's established protocol. [For cleaning, use your facility's established protocol.]

SpO₂ Sensors

 CAUTION: Never immerse sensors and clips in fluids. Do not pour or spray any liquids onto the sensor. Caustic or abrasive cleaners will cause permanent damage. Do not open the case of the finger clip sensor more than 45° or the case will be damaged.

Clean the sensor with a soft cloth dampened with a mild medical grade disinfectant or isopropyl alcohol. Remove all tape residues if tape was used during the study. Allow the sensor to dry thoroughly before reusing.

Preventative Maintenance

System Self Checks

Tango M2 performs a range of system and software checks during normal operation. If Tango detects a problem, it will display an error code with a message to contact SunTech Customer Service.

 WARNING: DO NOT USE the monitor if it displays a greater than zero pressure with no cuff attached.

Replaceable Parts

On a routine basis, inspect the monitor, cuff, SpO₂ sensor, cables, and hoses for cracks, fraying, or kinks. Immediately replace any damaged part. Refer to the list of Accessories & Replacement Parts in this guide (PG #48). Use only approved accessories with the Tango M2. Inaccurate readings may result if non-approved accessories are used.

 CAUTION: The monitor does not contain any user serviceable parts and should only be opened by an authorized service representative. DO NOT remove covers or break the warranty seal as this will void the manufacturer's warranty.

Orbit-K Cuff

It is recommended that you replace the Orbit-K cuffs, microphones and patient cable annually to maintain measurement accuracy.

If the cuff does not need replacement, you can replace just the microphone. To remove the microphone from cuff, open the Velcro strip and gently pull the microphone out of the sleeve.

SpO₂ Sensor

You can replace the SpO₂ sensor by unplugging it from the Tango monitor and replacing it with a new Nonin SpO₂ sensor.

Routine Calibration

Check the calibration of your Tango M2 annually to verify the accuracy of the pressure transducers and indicators.



CAUTION: Calibration should be done by a biomedical technician or other person familiar with the Tango M2 monitor.

Please contact SunTech Medical for instructions to access “Verify Calibration”. Instructions are also available in the Tango M2 service manual (SunTech Part 80-0056-00).

For customers in the Americas:
 SunTech Medical, Inc.
 Service Department
 507 Airport Boulevard, Suite 117
 Morrisville, NC 27560 USA
 Tel: 800.421.8626
 919.654.2300
 Fax: 919.654.2301

For customers in Europe, the Middle East, Africa, Asia, and the Pacific:



SunTech Medical, Ltd.
 Service Department
 Oakfield Industrial Estate
 Stanton Harcourt Road
 Eynsham, Oxfordshire OX29 4TS
 England
 Tel: 44 (0) 1865.884.234
 Fax: 44 (0) 1865.884.235

Equipment Required:

- Calibrated electronic sphygmomanometers or equivalent.
- 500 mL volume or the Orbit-K Adult Plus cuff wrapped around something that will not break or crush (no glass).
- Hand Inflation Bulb with bleed valve.
- Tubing, Tee pieces, and miscellaneous connectors or you can order the T-Tube Kit (SunTech Part 98-0030-00).

Procedure:

When Verify Calibration is accessed, the monitor will close its bleed valves and display the pressure applied to the patient hose connector.

Verify Tango M2 calibration by manually inflating and checking the sphygmomanometer against the pressure reading on the monitor display. The displayed pressure reading should be within ± 2 mmHg of the pressure value on the mercury sphygmomanometer through a range of pressures from 0 to 300mmHg. If not, contact SunTech Medical about calibration.

Once the calibration has been confirmed, press the SELECT button to exit the calibration screen.

Software Updates

If a Tango M2 software update is available, you can update your monitor easily using the USB-A port.

Software updates should only be installed by a trained technician who is familiar with operation of the Tango M2. Please call your SunTech Medical Customer Service if you need assistance.

Download the software update from the SunTech Medical website (www.SunTechMed.com) onto a USB-A flashdrive.

Insert the USB-A flashdrive into the USB-A port on the back of the monitor.

Select [Main Menu](#) > [Monitor Setup](#) > [System Info](#) > [Software Update](#).

Follow the messages on the monitor screen to complete the update.

Message	Meaning	Action
Software update in progress	Update is being processed	
Software update complete	New software was installed.	If the message includes “Tango M2 will now reboot”, select “OK” to complete the update process.
No Flash Drive Found	Tango M2 does not detect the flashdrive.	Wait a few moments then select Retry. If the flashdrive is still not detected, remove the drive then reinsert the drive. Wait a few moments for the Tango M2 to recognize the drive.

Software is same as or older than currently installed.

No update will be performed

Select "Close"

Product Disposal



Do not dispose of this product as unsorted municipal waste. Prepare this product for reuse or separate collection as specified by Directive 2012/19/EU of the European Parliament and the Council of the European Union on Waste Electronic and Electrical Equipment (WEEE).

The SunTech Tango M2 device encloses a small lithium ion battery and Printed Circuit (PC) board that contain materials which may be hazardous to human health. The battery cannot be easily removed and therefore the Tango M2 must be disposed of in an environmentally responsible way or returned to SunTech Medical. A prepaid return label can be obtained. Please see our website for more information about our environmental policy at <http://www.suntechmed.com/about-suntech/environmental-policy>.

Do not dispose of battery in fire as it may explode. Do not short-circuit battery as it may cause burns.

Cuff Disposal

Do not return used cuffs. Used blood pressure cuffs may be contaminated medical waste and should be dealt with in accordance to your local regulations. The Orbit-K cuff contains a microphone/cable assembly which should be removed and disposed of separately as specified by the WEEE directive.

8. Accessories & Replacement Parts

Contact your SunTech Medical sales representative to purchase the following items. Visit SunTechMed.com/library for additional instructions for the following items.

Description	Part Number	Details
<i>Orbit-K™ Cuffs & K-Sound Microphone: Orbit-K packs include K-Sound microphone (P/N 98-0235-00).</i>		
Small Adult	98-0062-21	18 – 27 cm
Adult	98-0062-22	25 – 35 cm
Adult Plus	98-0062-25	27 – 40 cm
Large Adult	98-0062-23	32 – 44 cm
18-inch K-Sound microphone	98-0235-00	
<i>Single Patient Use Kits: SPU Kits are packaged 20 kits to a box (a microphone is not included).</i>		
SPU Kit Small Adult	98-0700-01	17 - 25 cm
SPU Kit Adult	98-0700-02	23 - 33 cm
SPU Kit Adult Long	98-0700-03	23 - 33 cm
SPU Kit Large Adult	98-0700-04	31 - 40 cm
SPU Kit Large Adult Long	98-0700-05	31 - 40 cm
12-inch K-Sound Microphone	98-0235-01	

Description	Part Number	Details
<i>Tango M2 Cables & Accessories</i>		
Power Supply	19-0012-01	Power supply does not come with a power cord. Select the region-specific power cord from the following options.
US/Canada Power Cord	91-0003-00	
UK Power Cord	91-0003-06	
EU Power Cord	91-0003-05	
Australia/New Zealand Power Cord	91-0003-07	
China Power Cord	91-0003-08	
Italy Power Cord	91-0003-09	
Switzerland/Liechtenstein Power Cord	91-0003-10	
India/South Africa Power Cord	91-0003-11	
Israel Power Cord	91-0003-12	
ECG Patient Cable	91-0004-00	Only for Tango M2 with Internal ECG
Patient Cable, 15 ft	91-0127-01	
Xpod® SpO ₂ kit, w/Adult Finger Clip	98-0233-01	Includes Xpod® and Adult Finger Clip Sensor
Xpod® Pulse Oximeter	91-0125-01	
Purelight® Adult Finger Clip	52-0003-00	Sensor only
Pole/Rail Clamp w/ screws	36-0001-01	Enables the Tango M2 to be mounted to a pole
Wrist Strap	98-0003-00	
T-tube Kit	98-0030-00	For calibration check
Headphones	51-0000-00	
Extension cable for headphones	91-0076-00	
Deluxe Mobile Stand	46-0040-00	Requires Mobile Stand Mount below for use with Tango M2
Mount for Deluxe Mobile Stand	46-0040-02	
Preventative Maintenance Kit	99-0027-39	Contains 1 Adult Plus cuff with microphone, 1 Adult Large cuff with Microphone, and 1 Tango M2 Patient Cable
<i>Documentation & Extended Warranties</i>		
User Manual CD	27-0135-A1	
Service manual	80-0056-00	
Additional One-year Warranty	83-0018-00	Extended warranty (1 year)
Three Year Extended Warranty	83-0019-00	Extended warranty (3 years, purchased at one time)

Appendix B contains a list of cables available from SunTech Medical to connect Tango M2 to various stress systems

9. Information Signals and Alarms

Information Signals

If Tango M2 has a problem taking a blood pressure measurement, an audible alarm of 3 beeps will sound and an Information Signal will appear on the monitor screen. Take action as directed on the screen, or as suggested in the table below.

NOTE: If a blood pressure reading results from a measurement that triggers an Information Signal, that reading will not appear in the Graph View.

Press any button to clear an Information Signal.

Information Signals will also be cleared when a BP measurement is initiated, either by an external prompt from the stress system or a timed interval prompt.

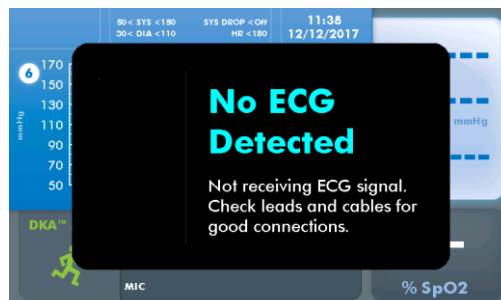

Information Signal	Reason	Solution
Displayed in either DKA™ MODE or OSC MODE		
Air Leak: Check cable connections at cuff and Tango M2.	Monitor will terminate a BP reading if target inflation is not reached in 60 seconds.	Make sure cuff and patient cable are not leaking. Make sure patient cable is properly connected to monitor.
Cuff Overpressure: Check patient cables for kinks. Drop arm to side and relax.	Monitor will terminate a BP reading if air hose or BP cuff has reached an unreasonably high pressure. No BP reported.	Have patient drop arm by their side during BP reading (avoid excessive bending of the arm). Make sure patient cable is not pinched or blocked.
Service required: Please call SunTech: U.S.: 1.800.421.8626 EMEA: +44 (0) 1865.884.234 Asia & Pacific: +852.2251.1949	Monitor has a system failure.	Contact your nearest SunTech Medical Service Department or authorized service agent. Monitor must be sent to SunTech Medical for repair.
Measurement Delayed: This measurement has been delayed. Next reading will occur as scheduled.	Measurement was delayed.	Next BP reading will occur as scheduled.
Repeat BP: Drop arm to side and repeat BP.	The monitor/device could not get a BP reading.	Start new BP reading via the Stress System or using the Tango M2 START/STOP button. Have patient drop arm by their side during BP reading (avoid excessive bending of the arm).
Blocked Hose: Make sure there are no sharp bends or pinches in the patient hose.	Pneumatic hose blockage.	Make sure there are no sharp bends or pinches in the patient hose.
Information Signal	Reason	Solution
Displayed only in DKA™ MODE		

Excessive Arm Movement	Excessive K-sound noise or arm movement.	Instruct patient to drop arm to side, reduce the bending of the arm and relax arm muscles.
Check ECG	ECG signal is weak, erratic or missing for more than 3 seconds. No BP reported.	<p>Set Waveform Display to ECG to verify monitor is receiving ECG Signal: (Main Menu > View > Waveform Display).</p> <p>If HR / ECG signal are present: Press START/STOP to take another reading.</p> <p>If error repeats, patient may have ECG problems which prevent Tango M2 from reading their blood pressure in DKA mode.</p> <p>If ECG signal is not present: Make sure that ECG lead connections to rear panel are secure.</p> <p>Make sure patient's skin is properly prepared and that ECG electrodes are correctly placed.</p> <p>Review Interface Notes for your stress system. Make sure the correct stress system setting is selected. (If "Custom", make sure the correct ECG Trigger is selected.)</p>
Check Mic: Check mic position and cable connection.	Weak, missing, or no K-Sounds detected. No BP reported.	<p>Make sure microphone is positioned over the brachial artery.</p> <p>Make sure cuff connections to patient cable are secure.</p> <p>Make sure that patient cable connections to rear panel are secure.</p> <p>Check microphone. If it is bent, or its wire is not securely connected, replace microphone.</p> <p>Test microphone by tapping the cuff; check for a signal on the Waveform Display. If signal is flat, replace microphone.</p> <p>Replace microphone and cuff annually.</p> <p>Review Interface Notes for your stress system. Make sure the correct stress system setting is selected. (If "Custom", make sure the correct ECG Trigger is selected.)</p>

No ECG detected: Not receiving ECG signal. Check leads and cables for good connections.	Monitor is not receiving ECG signal.	<p>Review Interface Notes for your stress system. Make sure the correct stress system setting is selected. (If "Custom", make sure the correct ECG Trigger is selected.)</p> <p>If using Internal ECG option, make sure a Custom ECG Trigger is set to INTERNAL.</p> <p>Make sure cables are correctly seated to their connectors and show no signs of damage.</p> <p>Set Waveform Display to ECG to verify monitor is receiving ECG Signal: (Main Menu > View > Waveform Display).</p>
---	--------------------------------------	---

Inflation too low	<p>K-Sounds were detected within 10 mmHg of target cuff inflation pressure.</p> <p>BP not reported.</p>	<p>BP reading may be inaccurate.</p> <p>Check Initial Inflate and Max Inflate settings.</p> <p>Have patient drop arm by their side during BP reading and avoid excessive movement or bending of the arm.</p> <p>Take another BP reading.</p>
-------------------	---	--

Information Signal	Reason	Solution
Displayed only in OSC MODE		
Excessive Arm Movement: If patient is exercising, press DKA/OSC to enter DKA EXERCISE Mode.	Excessive arm movement. May result in no BP reading.	Set monitor to DKA MODE.
Check cuff: Check the cuff for correct size and placement.	Weak or no oscillometric signal.	<p>Make sure cuff is properly connected.</p> <p>Make sure cuff is the right size.</p>
Exceeded Measurement Time: Check Cuff/ Air Hose	Pneumatic hose blockage.	<p>Have patient drop arm by their side during BP reading and avoid excessive movement or bending of the arm.</p> <p>Make sure patient cable is not pinched or blocked.</p>

Alarms

Alarm Types

The Tango M2 can set clinical alarms for different patient physiological parameters as listed in the table below. The Tango M2 uses two types of high priority alarms, Patient Physiological (clinical) alarms and Technical (equipment limitation) type alarms. All alarms indicate a potential of injury if the alarm is ignored or misunderstood. Ensure that appropriate resuscitation equipment and personnel are available at all times during the procedure.

Patient Physiological Alarms

When an alarm threshold setting is set, an alarm will sound when the threshold setting is met during a blood pressure measurement. When a physiological alarm occurs, the parameter that triggered the alarm will be displayed in red text on the screen and an audible alarm will sound. More than one alarm threshold can be set as desired. These alarms are immediate and there is no delay inherent in the determination of an alarm condition. Refer to the table below for the types of Patient Physiological Alarms available. Alarm thresholds are set using [Main Menu > Alarms](#).

Patient Physiological Alarms	Alarm Range
High Systolic BP	User settable from 130 to 270mmHg
Drop in Systolic BP	User settable from 45 to 100mmHg
High Diastolic BP	User settable from 30 to 160mmHg
Low Systolic BP	User settable from 40 to 110mmHg
Low Diastolic BP	User settable from 20 to 90mmHg
High Heart Rate	User settable from 90 to 200 beats per minute

The operator of the device should remain within viewable distance of the Tango M2 in order to be able to see the visual alarm indicators.

To verify the functionality of the alarm system, follow these steps:

- 1) Setup the Tango M2 for a reading following the instructions in this manual.
- 2) Take a baseline oscillometric reading on a patient.
- 3) Using the Alarm Menu, set the SYS High alarm to 20-30 mmHg below the systolic blood pressure given in step 2.
- 4) Take another oscillometric reading on the patient.
- 5) Verify that, if the alarm condition is met, the alarm sounds and visual indicators are displayed.

Technical Alarms

Technical alarms are triggered when measured values fall outside the measuring range of the equipment. These alarms may occur simultaneously with a physiological alarm. When a technical alarm condition occurs, an audible alarm will sound and the measured value causing the alarm will be displayed in red. These alarms are immediate and there is no delay inherent in the determination of an alarm condition. In Graph View, the chart will display out of range values in red. If only part of a full BP reading is out of range, only that part of the bar will be red (top = systolic; bottom = diastolic).

Alarm Acknowledge

The alarms on the Tango M2 can be acknowledged. Acknowledging the alarms will silence the remainder of the audible alarm. To acknowledge an alarm, press the up or down arrow button while the audible alarm is sounding. When an alarm is acknowledged, the Tango M2 will display the bell cancel symbol on the main screen.

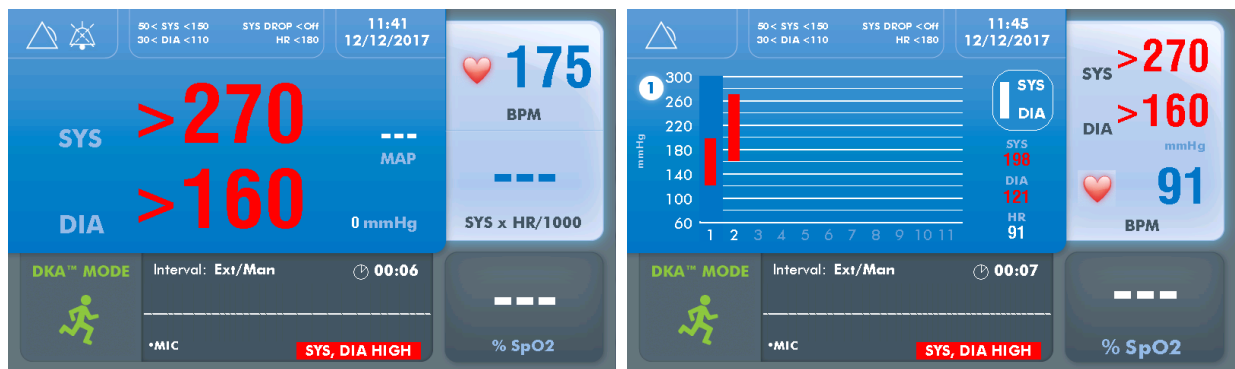

Service Centers

For customers in the Americas:
SunTech Medical, Inc.
Service Department
507 Airport Boulevard, Suite 117
Morrisville, NC 27560 USA
Tel: 800.421.8626
919.654.2300
Fax: 919.654.2301

For customers in Europe, the Middle East, Africa, Asia, and the Pacific:



SunTech Medical, Ltd.
Service Department
Oakfield Industrial Estate
Stanton Harcourt Road
Eynsham, Oxfordshire OX29 4TS
England
Tel: 44 (0) 1865.884.234
Fax: 44 (0) 1865.884.235

10. Frequently Asked Questions

The Tango M2 displays an Information Signal. What does it mean and what do I do?

There are 2 places where you can find more information about Information signals:

1. See the E-Library within your Tango M2 for quick troubleshooting tips. You can find the E-Library under the Main Menu; select [Monitor Setup > E-Library > Information Signals](#).
2. You can also look in the Tango M2 User Manual under the Information Signals & Alarms section for details on each Information Signal and solution.

The Tango M2 monitor returns a result of 0/0 after blood pressure (BP) measurements. What do I need to do to get a BP reading?

There are certain noisy conditions where the Tango M2 cannot accurately measure BP. When the Tango M2 encounters these situations, it returns a reading of 0/0. Microphone placement is critical for reliable operation of the Tango M2; there are many places to find cuff placement help.

1. See the E-Library within your Tango M2 for quick cuff placement tutorials. You can find the E-Library under the Main Menu; select [Monitor Setup > E-Library > Tutorials](#).
2. Look in the Tango M2 User Manual under the Using Tango M2 during a Stress Test section for details on each type of cuff; the Orbit-K and the Single Patient Use (SPU) kit.
3. Follow the instructions in the Cuff Tutorial (located on the SunTech Medical website under [Support > Customer Technical Support > Video Tutorials](#)) for correct microphone placement.

Can I use a heart rate or blood pressure simulator to test whether the Tango M2 is working correctly with my stress system?

You cannot use a heart rate or blood pressure simulator to test whether the Tango M2 is working with your stress system. The Tango M2 monitor requires that the ECG signal and the Korotkoff sounds, collected by the microphone in the cuff, originate from the same source, meaning the patient.

How can I adjust the brightness of the Tango M2 display?

You can adjust the contrast of the Tango M2 display by following these steps:

1. When the operating screen is displayed, press the SELECT button once. This will bring up the Main Menu screen.

2. Using the UP or DOWN arrows, highlight Monitor Setup and press the SELECT button.
3. Using the UP or DOWN arrows, highlight Brightness and press the SELECT button.
4. Using the UP or DOWN arrows, modify the contrast of the screen. When you are finished, and press the SELECT button to confirm the choice.
5. Using the UP or DOWN arrows, select EXIT twice to return to the operating screen.

How can I get MAP on my Tango M2?

Register your Tango M2 Monitor online or through mail to receive MAP as a function on your Tango M2 monitor. Please note that due to FDA Regulations MAP is not available to the United States market. ([Support](#) > [Sales Support](#) > [Product Registration](#)).

How do I clean the Orbit-K cuff after a stress test?

You can do either of the following:

1. Use a medical grade mild disinfectant wipe on the cuff or spray a cleaning solution onto a cloth and wipe the cuff. Afterwards, lay flat or line dry.
2. Remove the bladder and microphone from the outer shell of the Orbit-K cuff. Machine wash the shell in warm water with a mild detergent (50-140°F or 10-60°C). Lay flat or line dry the cuff. Do not place the cuff in a dryer.



CAUTION: Do not machine wash bladder or microphone.

My Tango M2 displays a message, “Please VERIFY CALIBRATION” or “Equipment Maintenance and Calibration Required.” What do I do?

Verification of Pressure Calibration is required every year to maintain the accuracy of the Tango M2’s BP readings. You will need to contact the SunTech Medical Service Center for help. In addition, the following items will be needed to verify calibration.

Equipment Required:

1. Calibrated electronic manometer or equivalent.
2. 500mL volume or the Orbit-K Adult Plus cuff wrapped around something that will not break or crush (no glass).
3. Hand Inflation Bulb with bleed valve.
4. Tubing, Tee pieces, and miscellaneous connectors or you can order the T-Tube Kit (SunTech Part # 98-0030-00).

Service Centers

For customers in the Americas:
 SunTech Medical, Inc.
 Service Department
 507 Airport Boulevard, Suite 117
 Morrisville, NC 27560 USA
 Tel: 800.421.8626
 919.654.2300
 Fax: 919.654.2301

For customers in Europe, the Middle East, Africa, Asia, and the Pacific:



SunTech Medical, Ltd.
 Service Department
 Oakfield Industrial Estate
 Stanton Harcourt Road
 Eynsham, Oxfordshire OX29 4TS
 England
 Tel: 44 (0) 1865.884.234
 Fax: 44 (0) 1865.884.235

11. Technical Information

EMC Statement

This equipment has been tested and found to comply with the limits for medical devices to IEC60601-1-2: 2007. These limits are designed to provide reasonable protection against harmful interference in a typical medical installation. This equipment generates, uses and can radiate radio frequency energy and, if not installed and used in accordance with the instructions, may cause harmful interference to other devices in the vicinity. However, there is no guarantee that interference will not occur in a particular installation. If this equipment does cause harmful interference to other devices, which can be determined by turning the equipment off and on, the user is encouraged to try to correct the interference by one or more of the following measures:

- Reorient or relocate the receiving device.
- Increase the separation between the equipment.
- Connect the equipment into an outlet on a circuit different from that to which the other device(s) are connected.
- Consult the manufacturer or field service technician for help.

Portable and mobile RF communications equipment can affect Medical Electrical Equipment. Use of accessories, transducers, and cables other than those specified may result in increased emissions or decreased immunity of the Tango M2. The Tango M2 should not be used adjacent to or stacked with other equipment. If adjacent or stacked use is necessary, the Tango M2 should be observed to verify normal operation in the configuration in which it will be used.

Guidance and Manufacturer's Declaration – Electromagnetic Emissions		
The Tango M2 Monitor is intended for use in the electromagnetic environment specified below. The customer or the user of the Tango M2 Monitor should assure that it is used in such an environment.		
Emissions test	Compliance	Electromagnetic Environment – Guidance
RF emissions CISPR 11	Group 1 ed 5.0 (with A1:2010)	The Tango M2 Monitor uses RF energy only for its internal function. Therefore, its RF emissions are very low and are not likely to cause any interference in nearby electronic equipment.
	Class A	Special provisions cover professional medical electrical equipment. This means only the Tango M2 Monitor is suitable for use in equipment/systems for use by healthcare professionals and that are not intended for sale to the general public. They are predominantly intended to be connected (e.g. in hospitals or doctor's offices) to dedicated supply
Harmonic emissions IEC 61000-3-2	Class A	
Voltage fluctuations/ flicker emissions IEC 61000-3-3	Complies	

Guidance and Manufacturer's Declaration – Electromagnetic Emissions

		systems (normally fed by separation transformers).
--	--	--

Guidance and Manufacturer's Declaration – Electromagnetic Immunity

The Tango M2 Monitor is intended for use in the electromagnetic environment specified below. The customer or the user of the Tango M2 Monitor should assure that it is used in such an environment.

Immunity Test	IEC 60601 Test Level	Compliance Level	Electromagnetic Environment-Guidance
Electrostatic discharge (ESD) IEC 61000-4-2	±6 kV contact ±8 kV air		Floors should be wood, concrete or ceramic tile. If floors are covered with synthetic material, the relative humidity should be at least 30 %.
Electrical fast transient/burst IEC 61000-4-4	±2 kV for power supply lines ±1 kV for input/output lines		Mains power quality should be that of a typical commercial or hospital environment.
Surge IEC 61000-4-5	±1 kV differential mode ±2 kV common mode		
Voltage dips, short interruptions and voltage variations on power supply input lines IEC 61000-4-1	<5 % UT (>95 % dip in UT) for 0,5 cycle 40 % UT (60 % dip in UT) for 5 cycles 70 % UT (30 % dip in UT) for 25 cycles <5 % UT (>95 % dip in UT) for 5 sec		Mains power quality should be that of a typical commercial or hospital environment. If the user of the Tango M2 Monitor requires continued operation during power mains interruptions, it is recommended that the Tango M2 Monitor be powered from an uninterruptible power supply or a battery.
Power frequency (50/60 Hz) magnetic field IEC 61000-4-8	3 A/m		Power frequency magnetic fields should be at levels characteristic of a typical location in a typical commercial or hospital environment.

NOTE: UT is the a.c. mains voltage prior to application of the test level

In the event of a power loss to the monitor, all data and user settings are saved. The monitor will power-up with the same settings and data as prior to the power loss.

Immunity Test	IEC 60601 Test Level	Compliance Level	Electromagnetic Environment-Guidance
Conducted RF IEC 61000-4-6	3 Vrms 150 kHz to 80 MHz	3V	Portable and mobile RF communications equipment should be used no closer to any part of the Tango M2, including cables, than the recommended separation distance calculated from the equation
Radiated RF IEC 61000-4-3	3 V/m 80 MHz to 2.5 GHz	3V/m	

			<p>applicable to the frequency of the transmitter.</p> <p>Recommended separation distance</p> $D = [3,5/V1] \sqrt{P}$ $D = [3,5/E1] \sqrt{P} \text{ 80 Mhz to 800 Mhz}$ $D = [7/E1] \sqrt{P} \text{ 800 Mhz to 2.5 Ghz}$ <p>Where P is the maximum output power rating of the transmitter in watts (W) according to the transmitter manufacturer and d is the recommended separation distance in meters (m).</p> <p>Field strengths from fixed RF transmitters as determined by an electromagnetic site surveya, should be less than the compliance level in each frequencyb.</p> <p>Interference may occur in the vicinity of equipment marked with the following symbol:</p> 
--	--	--	--

NOTE 1: At 80 MHz and 800 MHz, the higher frequency range applies
NOTE 2: These guidelines may not apply in all situations. Electromagnetic propagation is affected by absorption and reflection from structures, objects and people.

- a. Field strengths from fixed transmitters such as base stations for radio (cellular/cordless) telephones and land mobile radios, amateur radio, AM and FM radio broadcast and TV broadcast cannot be predicted theoretically with accuracy. To assess the electromagnetic environment due to fixed RF transmitters, an electromagnetic site survey should be considered. If the measured field strength in the location in which the Tango M2 is used exceeds the applicable RF compliance level above, the Tango M2 should be observed to verify normal operation. If abnormal performance is observed additional measures may be necessary such as reorienting or relocating the Tango M2.
- b. Over the frequency range 150kHz to 80 MHz, field strengths should be less than [V1] V/m.

Recommended separation distances between portable and mobile RF communications equipment and the Tango M2

The Tango M2 is intended for use in an electromagnetic environment in which radiated RF disturbances are controlled. The customer or the user of the Tango M2 can help prevent electromagnetic interference by maintaining a minimum distance between portable and mobile RF communications equipment (transmitters) and the Tango M2 as recommended below, according to the maximum output power of the communications equipment.

Rated maximum output power of transmitter. Watts (W)	Separation distance according to frequency of transmitter meters (m)		
	150 kHz to 80 MHz $D = [3,5/V1] \sqrt{P}$	80 MHz to 800 MHz $D = [3,5/E1] \sqrt{P}$	800 MHz to 2,5 GHz $D = [7/E1] \sqrt{P}$
0.01	0.12	0.12	0.23

Recommended separation distances between portable and mobile RF communications equipment and the Tango M2			
0.1	0.38	0.38	0.73
1	1.2	1.2	2.3
10	3.8	3.8	7.3
100	12	12	23
NOTE 1: at 80 MHz and 800 MHz, the separation distance for the higher frequency range applies. Note 2: These guidelines may not apply in all situations. Electromagnetic propagation is affected by absorption and reflection from structures, objects and people.			

For transmitters rated at a maximum output power not listed above, the recommended separation distance d in meters (m) can be estimated using the equation applicable to the frequency of the transmitter, where P is the maximum output power rating of the transmitter in watts (W) according to the transmitter manufacturer.

Specifications, Blood Pressure Measurement

Measurement:	Auscultatory, using R-wave gating and k-sound analysis, during all static and active phases of stress testing. Systolic pressures correlate to a K-1 Korotkoff sound. Diastolic pressures correlate to K-5 Korotkoff sound. The device is designed to function in the presence of a normal ECG sinus rhythm. There are some physical conditions (i.e. Bundle Branch Block, Arrhythmias, Atrial Fibrillation, Ventricular Fibrillation, Pacemakers, etc.) that may limit the ability of Tango M2 to obtain an accurate reading.	
Range:	Pressure (DKA Mode): Diastolic: 20-160 mmHg / Systolic: 40-270 mmHg	Heart Rate: 40-200 BPM (beats per minute)
	Pressure (OSC Mode): Diastolic: 20-160 mmHg / Systolic: 40-260 mmHg	
Accuracy:	Meets or exceeds ANSI/AAMI/ISO 81060-2:2009 standard for non invasive accuracy (± 5 mmHg mean error with 8mmHg standard deviation).	
Conditions for Use:	Operating: 10°C (50°F) to 40°C (104°F) 15 – 90% RH non-condensing - 700 kPa - 1060 kPa. Operating the monitor in an environment at maximum temperature can produce temperatures exceeding 41°C (41.6°C highest recorded) on a patient applied part. It is up to the operator to determine if this temperature is too high based upon the condition of a patient and, if so, to ensure the ambient temperature of the environment is 38°C or below. Storage: -20°C (-4°F) to 65°C (149°F) 15 – 90% RH non-condensing - 500 kPa - 1060 kPa. Performance can be affected if, used or stored outside the specified temperature, humidity, or altitude listed in the ranges above.	
Power:	External power supply, use only SunTech part number 19-0012-01. Input: 100-240 VAC @ 1.5A max, 50-60 Hz. Output +9VDC @ 5A IEC 320 type input connector.	
Calibration:	The accuracy of cuff -pressure transducers/indicators should be verified annually.	
Safety Systems:	Independent hardware over-pressure circuit and redundant software overpressure algorithm to limit cuff pressure to less than 300 mmHg (+20/-10mmHg). Independent hardware timing circuit and redundant software timer algorithm to limit the duration of a blood pressure cycle to less than 180 seconds.	
Dimensions:	Size: 24.0 cm x 17.4 cm x 11.5 cm (9.5" x 6.9" x 4.5")	

	Weight: 1.68 kg (3.725 lb, 59.6 oz)
Classifications:	Equipment Classification: Class I Mode of Operation: Continuous.

Standards

FDA Rec. #	Standard Designation	Description/Title
5-90	ISO 15223-1: 2016	Medical devices – Symbols to be used with medical device labels, labelling and information to be supplied – Part 1 General Requirements
5-102	IEC60417: 2002 DB	Graphical Symbols for Use On Equipment
5-103	ISO 7000: 2014	Graphical Symbols for Use On Equipment - Registered Symbols
5-104	IEC/TR60878: Ed. 3.0 b:2015	Graphical Symbols for Electrical Equipment in Medical Practice
19-4	AAMI/ANSI ES60601-1: 2005/(R)2012 And A1:2012, C1: 2009/(R)2012 And A2: 2010/(R)2012	Medical Electrical Equipment - Part 1: General Requirements for Basic Safety and Essential Performance (IEC 60601-1:2005, Mod). (General II (ES/EMC))
2-118	AAMI/ANSI/ISO 10993-1:2009	Biological Evaluation Of Medical Devices Part 1: Evaluation And Testing Within A Risk Management Process - Fourth Edition
3-122	ANSI/AAMI/ISO 81060-2:2013	Non-invasive sphygmomanometers - Part 2: Clinical validation of automated measurement type
n/a	IEC 60601-1: 2005 + A1:2012	Medical Electrical Equipment Part 1: General Requirements For Basic Safety and Essential Performance
19-2	IEC 60601-1-2: 2007	Medical Electrical Equipment - Part 1-2: General Requirements For Basic Safety And Essential Performance - Collateral Standard: Electromagnetic Compatibility - Requirements and Tests
3-123	IEC 80601-2-30: 2013, Ed. 1.1	Medical electrical equipment - Part 2-30: Particular Requirements for the Basic Safety and Essential Performance Of Automated Non-Invasive Sphygmomanometers
1-85	ISO 80601-2-61: 2011	Medical Electrical Equipment - Part 2-61: Particular Requirements for Basic Safety and Essential Performance Of Pulse Oximeter Equipment
5-114	IEC 62366-1: 2015, Ed 1.0	Medical devices - Part 1: Application of usability engineering to medical devices [Including CORRIGENDUM 1 (2016)]
5-89	IEC 60601-1-6 Edition 3.1 2013-10	Medical electrical equipment - Part 1-6: General requirements for basic safety and essential performance - Collateral standard: Usability

Notes on Blood Pressure Data

Any blood pressure reading can be affected by the measurement site, the position of the patient, exercise, or the patient's physiologic condition. Environmental or operational factors which can affect the performance of the device and/or its blood pressure reading are pacemakers and common arrhythmias such as atrial or ventricular premature beats or atrial fibrillation, arterial sclerosis, poor perfusion, diabetes, age, pregnancy, pre-eclampsia, renal diseases, patient motion, trembling, and shivering.

Specifications, Pulse Oximetry

Non-Motion Accuracy:	70 – 100% ± 2 digits (± 1 Standard Deviation*)
Low Perfusion	70 – 100% ± 2 digits (± 1 Standard Deviation*)
Motion	70 – 100% ± 3 digits (± 1 Standard Deviation*)

* Standard Deviation is a statistical measure up to 32% of the readings may fall outside those limits.

A functional tester cannot be used to assess the accuracy of a pulse oximeter probe or a pulse oximeter monitor. Using Nonin SpO₂ simulator model 8000S the Tango M2 monitor will display a reading of approximately 98% SpO₂. The SpO₂ Cable has a rating of IPX1 meaning that the pulse oximeter is protected against harmful effects of dripping water per IEC 60529.

Limited Warranty

SunTech Medical, Inc. provides to the original purchaser the following limited warranty from date of invoice.

All serialized monitors	24 months
Orbit-K Cuffs	6 months
Accessories, i.e. patient cables, microphone, disposables	90 days

SunTech Medical, Inc. warrants each instrument to be free from defects in material and workmanship. Liability under this warranty covers servicing of the instrument when returned from the customer's facility within the United States prepaid to the factory. SunTech Medical, Inc. will repair any component(s) or part(s) that it finds to be defective during the period of this limited warranty. Should a defect become apparent, the original purchaser should first notify SunTech Medical, Inc. of the suspected defect. The instrument should be carefully packaged and shipped prepaid to:

SunTech Medical, Inc.
 Service Department
 507 Airport Boulevard, Suite 117
 Morrisville, NC 27560 USA
 Tel: 800.421.8626
 919.654.2300
 Fax: 919.654.2301

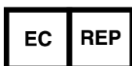

SunTech Medical, Ltd.
 Service Department
 Oakfield Industrial Estate
 Stanton Harcourt Road
 Eynsham, Oxfordshire OX29 4TS
 England
 Tel: 44 (0) 1865.884.234
 Fax: 44 (0) 1865.884.235

The instrument will be repaired in the shortest possible time and returned prepaid by the same shipping method as received by the factory.

This limited warranty is void if the instrument has been damaged by accident, misuse, negligence, act of God or serviced by any person not authorized by SunTech Medical, Inc.

This limited warranty contains the entire obligation of SunTech Medical, Inc. and no other warranties expressed, implied or statutory are given. No representative or employee of SunTech Medical, Inc. is authorized to assume any further liability or grant any further warranties except as herein.

Appendix A. Compatible Stress Systems

The following stress systems are compatible with Tango M2.

Many stress systems have pre-configured settings available in Tango M2's Main Menu. If your stress system does not have a pre-configured setting use the custom setting designated.

Stress System Manufacturer	Stress System	Pre-Configured Setting	Create a Custom Setting (Protocol; ECG Trigger)
Amedtec	ECGpro	ECGpro	
Burdick	Quest	Quest	
	HeartStride		SUNTECH; Digital Rising
Cambridge Heart	HearTwave II	HearTwave II	

	CH 2000	CH 2000	
Cardinal Health	Oxycon Jaegar		SUNTECH; Internal
Cardioline	Cube Stress		BOSOTRON; Digital Rising
Cardiolex	EC Sense		STANDARD; Digital Rising
Delmar Reynolds	CardioDirect	CardioDirect	
DMS	CardioScan		SUNTECH; Analog
EDAN	SE-1010 PC ECG		SUNTECH; Digital Rising
EDAN	ECG SE-12 Express		SUNTECH; Digital Rising
Esaote (Biosound)	Esaote Formul@	Formula/Formul@	
	Biosound Esaote Formula for Achimed	Formula/Formul@	
Fukuda Denshi	FCP-7541/7542	FCP-7541/7542	
	ML-3600	ML-3600	
	ML-9000	ML-9000	
GE	CardioSoft v6.01+	GE CardioSoft	
	Case / Case 8000	Case 8000	
GE (Marquette)	Case 12 / Case 15 / Case 16 / Centra	Case 12, Case 15, Case 16 or Centra	
	MAC 5000/5500	Mac 5000/5500	
	MAC VU	Mac-Vue-Stress	
Marquette	Hellige CardioSys	CardioSys	
	Sensormedics Max 1	Max-1	
MedSet Flashlight	ERGO (PADSY by	Medset	
Midmark Diagnostics	IQmark EZ Stress	IQmark EZ Stress	
Mortara	X-Scribe	X-Scribe	
Nasiff Associates	Cardio-Card	Cardio-Card	
Nihon Kohden	Cardiofax ECG 1550 /	ECG-1550/1560	
	Cardiofax ECG 9320A	ECG-1550/1560	
Norav	Stress ECG		SUNTECH; Digital Rising
Philips	StressVue (2nd Gen)	StressVue	
	StressVue (1st Gen)	StressVue	
	ST80i		SUNTECH; Digital Rising
Pulse Biomedical	QRS Card	QRS Card	
	QRS Oxford Medilog	Medilog Stress	
	Q-Stress V4.0+		SUNTECH; Digital Rising
Quinton	Q-Stress	Q-Stress	
	Q 4500	Q4500/Q5000	
	Q 3000 / Q 4000 / 710	Q3000/Q4000	
	CardioSoft	CardioSys	
Sensormedics Vmax (CareFusion)	Max-1	Max-1	
	SMC 3-lead		SUNTECH; Internal
	CASE 8000	Case 8000	
Viasys	Encore Vmax	CardioSys	
Welch Allyn	CardioPerfect	CardioPerfect	

Check for an updated list of Interface Notes available for download from the SunTech Medical website:
www.SunTechMed.com.

Appendix B. Cables for Compatible Stress Systems

Contact your SunTech Medical sales representative to purchase the following items:

RS-232 & ECG Interface Cables

Stress System	RS-232 Cable	ECG Trigger Cable
AMEDTEC ECGpro	91-0013-01	91-0066-01
Burdick Quest	91-0013-01	91-0011-01
Cambridge Heart CH 2000 & HearTwave II	91-0065-01 (RS-232 and ECG)	-----
Delmar Reynolds CardioDirect with CardioCollect	91-0013-01	91-0066-01
DMS	91-0013-01	91-0011-01
EDAN SE-1010	91-0013-01	Contact EDAN for cable
EDAN ECG SE-12	Contact EDAN for cable	Contact EDAN for cable
GE CardioSoft/cs	91-0013-01	91-0009-01
GE CASE	91-0013-01	91-0009-01
GE CASE 8000	91-0013-01	91-0009-01
Fukuda Denshi FCP-7541/7542; ML-3600; ML-9000	Contact Fukuda Denshi for cable	Contact Fukuda Denshi for cable
Marquette CASE 12 ; CASE 15; CASE 16	91-0012-00	91-0011-01
Marquette Centra	91-0012-00 / 91-0013-01	91-0011-01
GE MAC 5000/5500 Stress	91-0010-01	91-0009-01
Marquette / Sormedics Max-1	91-0010-01	91-0009-01
Marquette-Hellige CardioSys	91-0013-01	91-0016-00
Medset Flashlight Ergo	91-0013-01	-----
Midmark Diagnostics IQmark EZ Stress	91-0013-01	91-0011-01
Mortara X-Scribe	91-0013-01	91-0011-01
Nasiff Associates Cardio-Card	91-0013-01	91-0018-02
Nihon-Kohden Cardiofax ECG-9320A	91-0061-01	91-0060-00
Nihon-Kohden Cardiofax 1550/1560	91-0061-01	91-0018-02
Norav Stress	91-0013-01	91-0011-01
Oxford Medilog Stress/PBI QRS Card	91-0013-01	Contact PBI or Oxford
Philips Stress Vue	91-0013-01	91-0011-01
Philips ST80i	98-1010-00	91-0011-01
Quinton Q3000/Q4000/710	-----	91-0018-02
Quinton Q4500	91-0013-01	91-0018-02
Quinton Q-Stress	91-0013-01	91-0018-02
Welch Allyn CardioPerfect Workstation	91-0013-01	91-0018-03

Splitter Cables

Stress System	Part Number
GE CASE - use with echocardiograph	91-0053-01
GE CASE 8000 - use with echocardiograph	91-0053-01
Marquette / Sormedics Max-1 - use with echocardiograph	91-0053-01
Marquette MAC 5000 / 5500 - required	91-0069-00

USB Cables (Optional Cable, replaces RS-232 connection)

Stress System	Part Number
USB Connectivity Kit (Cable, Communication Software, and Instructions for Use) Please note that this kit can only be used with the Tango M2.	98-1010-00

Appendix C. SpO₂ Performance Accuracy

The table below shows ARMS values measured using 8000AA with XPod (OEM III) in a clinical study.

Statistic	Results	Specification
Bias 70-100	-1.54	
Bias 70-80	-1.41	
Bias 80-90	-1.97	
Bias 90-100	-1.28	
Between Subject Variance	7.4	
Within Subject Variance	0.7	
Arms 70-100	1.83	±2
Arms 70-80	1.72	±2
Arms 80-90	2.17	±3
Arms 90-100	1.59	±2

Testing Summary

SpO₂ accuracy, motion and low perfusion testing was conducted by Nonin Medical, Incorporated as described below.

SpO₂ Accuracy Testing

SpO₂ accuracy testing is conducted during induced hypoxia studies on healthy, non-smoking, light-to-dark skinned subjects during motion and no-motion conditions in an independent research laboratory. Study subjects were comprised of male and female participants between the ages of 19 and 35. The measured arterial hemoglobin saturation value (SpO₂) of the sensors is compared to arterial hemoglobin oxygen (SpO₂) value, determined from blood samples with a laboratory co-oximeter. The accuracy of the sensors in comparison to the co-oximeter samples measured over the SpO₂ range of 70 – 100%. Accuracy data is calculated using the root-mean-squared (Arms value) for all subjects, per ISO 80601-2-61.

Low Perfusion Testing

This test uses an SpO₂ Simulator to provide a simulated pulse rate, with adjustable amplitude settings at various SpO₂ levels. The module must maintain accuracy in accordance with ISO 80601-2-61 for SpO₂ at the lowest obtainable pulse amplitude (0.3% modulation).

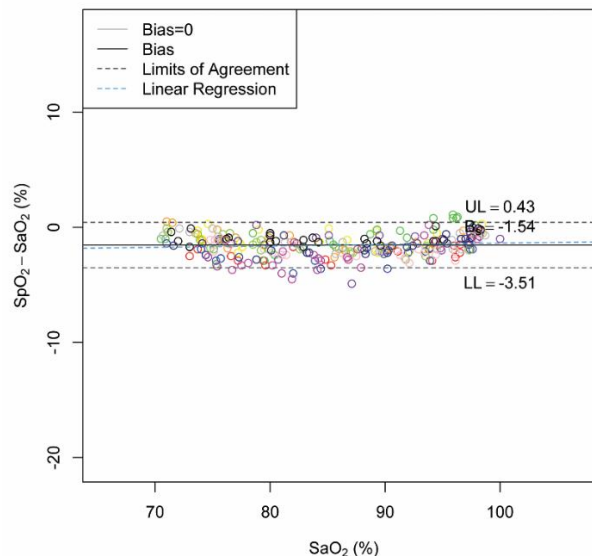

Appendix D. Downloading Instructions

Please use the following instructions to download the data from the measurement table and convert the data into an easy to understand Excel spreadsheet.

1. Insert the USB-A key into the Tango M2 monitor (it can take the monitor a few moments to identify the USB-A key).
2. Using your navigational arrows and select key go into the Main Menu and navigate to the Measurement Table, press the Select Key.
3. Navigate to the Download Data selection and press the Select Key.
4. A message will come up saying Download in Progress, when this is complete it will say Download Complete. You will be given 2 options, 1st to clear the measurement table (we recommend doing this after each time you download the data to your flashdrive) and 2nd to exit. Press the Select Key to Exit. You may now remove the USB-A Key.
5. Connect your USB-A Key to your PC. When the window opens there will be a file called Results. Open this file.
6. Inside the file there will be a document that needs to be identified. It will start with the year followed by the month and date and other identifiers; set up like YYYYMMDD#####. This is the unique identifier for each new BP data set that is pulled off the Tango M2 – you only need to worry with the date code as your identifier. Close out to move to the next step. This is the data that you have just pulled from the Tango M2

Tango M2 Excel Formatting of the Data

To open this data set as an Excel file please follow these steps:

1. Open the Microsoft Office Excel option in your Windows operating system (this should give you a blank Excel Spreadsheet).
2. Go to your Office Button (where you can select to open, save or print what you are working on) click on it and move down to select Open.
3. Chose "My Computer" under the Look In column
4. You will need to select the drive where the USB-A key is connected (should be the same drive that you had above). You should now see the file called Results
5. Click on the files called Results. Depending on your PC's settings you may have to go to the bottom of this window and select under "Files of Type", "All Files (*.*)" so that the information you just pulled from the Tango M2 can be displayed.
6. Select the file you just loaded onto this USB-A key from the Tango M2 and click Open.
7. A window will open telling you that the file you are trying to open is in a different format than specified by the file extension. It will be asking you if you want to open the document, select yes.
8. A new window will open taking you through 3 Text Import Steps. In the 1st window select Delimited (may already be selected) and change the File Origin to Unicode [UTF-8], then click Next. In the 2nd window select Tab and Comma (Tab may already be selected) and click Next. In the last window select General (may already be selected) and click Finish.
9. Your Excel Spreadsheet will now be formatted in columns and rows for easy viewing.